



INSTRUCTIONS

MODE D'EMPLOI

BEDIENUNGSANLEITUNG

MANUALE D'USO

MODO DE EMPLEO

DIAL GAUGE **E**

COMPARATEUR **F**

MESSUHR **D**

COMPARATORE **I**

COMPARADOR **S**

**Installing and replacing the battery
(or Power cable)**



Mise en place et remplacement de la
batterie (ou câble Power)

**Einbau und Austausch von Batterie
(oder Netzkabel)**

Installazione e sostituzione della batteria
(o del cavo di alimentazione)

**Colocación y sustitución de la batería
(o cable Power)**



No. 0  No. 0 (0,4x2,5mm) 

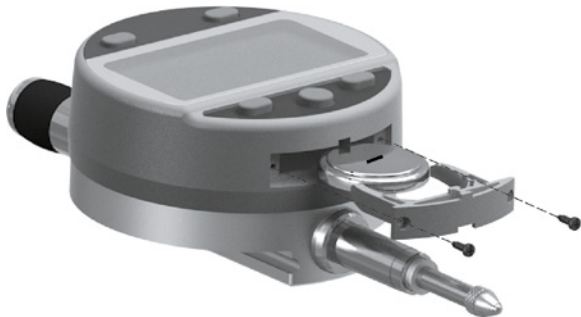

Battery / batterie / **batterie** / batteria / **bateria** : lithium 3V, type CR2032

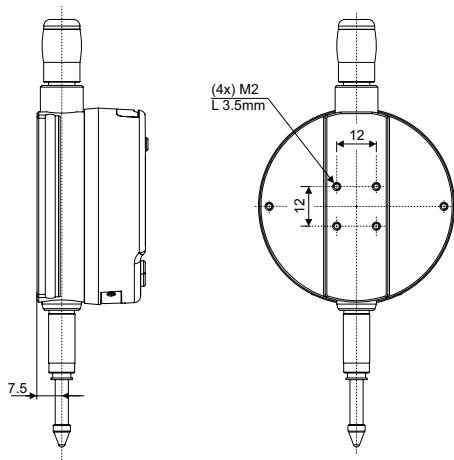

Diagram for rear fixings

Schéma de fixation arrière

Schema für die Befestigung hinten

Schema di fissaggio posteriore



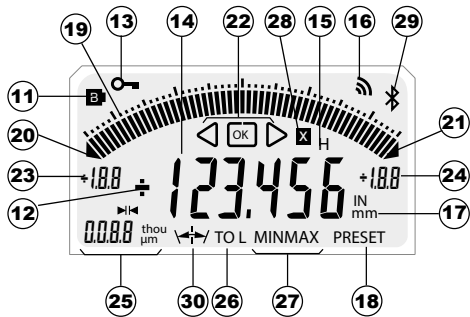
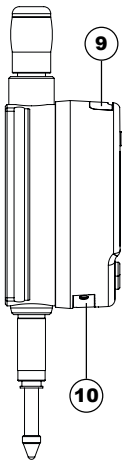
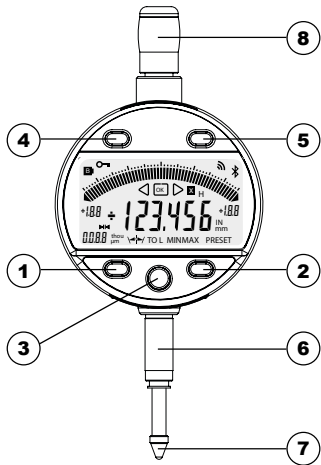

Esquema de fijación posterior

E

Description

1. MODE button
2. SET button
3. "Favourite" button
4. ◀ button
5. ▶ button
6. Clamping shaft Ø8 or 3/8"
7. Contact point Ø2/M2.5 or 4-48-UNF
8. Lifting cap
9. Slot for Proximity cable
10. Slot for battery or Power Cable
11. Low battery
12. +/- Indicator
13. Keypad lock (chap. 4)
14. 6-digit display
15. Hold measured value (chap. 10)
16. Send data (chap. 10)
17. Measurement units mm/INCH (chap. 3)
18. Preset mode (chap. 3)
19. Analogue scale (chap. 8)
20. Lower limit exceeded
21. Upper limit exceeded
22. Tolerance indicators
23. Analogue scale lower limit (chap. 8)
24. Analogue scale upper limit (chap. 8)
25. Unit and value of analogue scale (chap. 8)
26. Tolerance mode (chap. 4)
27. MIN/MAX/DELTA mode (chap. 4)
28. Multiplier (chap. 4)
29. *Bluetooth*® connection (chap. 9, depending on model)
30. Symmetrical tolerances (chap. 8.1)

1 . Operating features of the instrument

-  The instrument has two operating modes: First level functions (direct access) and Second level functions. In addition to the configuration functions, available access to the MIN, MAX and DELTA (TIR) mode, or display of tolerances (see chaps. 3 and 4)
-  The «favourite» key gives direct access to the function used most often (see chap. 9)
-  Sets a Preset value, reset the MIN/MAX mode, verifies a selection, and controls switching off the instrument. By default, SIS mode enables automatic switch-off with no loss of origin (see chap. 11).
-  With the «Left and Right» buttons, the user may change the extent of the analogue scale as well as enter the values of the nominal dimension and tolerance limits. (see chap. 6.2)

- Personalising the functions

It is possible to activate or de-activate certain functions of the instrument via RS232 (see chap. 13)

- Data transmission parameters

4800Bds, 7 bits, even parity, 2 stop bits

2. Start

Press a button. (For a *Bluetooth*[®] connection, see chap 9.)

3. First level functions

Each short press on **MODE** gives direct access to the First level functions :

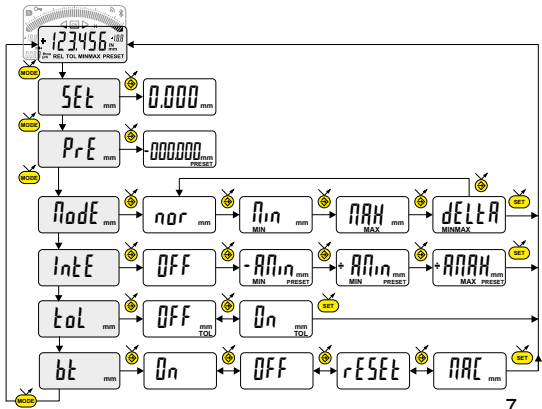

- [Normal mode: Zero reset
- [Min (Max) mode: Preset on the measured min (max) value

Inputting a Preset value (see chap. 7)

MIN, MAX measurement, DELTA (TIR) (see chap. 5)

2 points measurement (Dynamic preset) (see chapter 11)

Tolerance display (inputting tolerance limits, see chap. 6)

Bluetooth® (depending on model). Enable / disable, reset Bluetooth® module or display its MAC address.

4. Second level functions

Prolonged pressure (>2s) on **MODE** gives access to the Second level functions. Then, each short press on **MODE** accesses the required function:

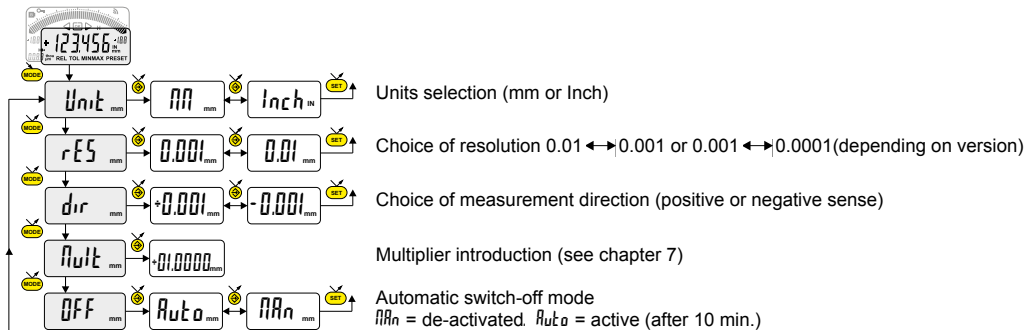

..... continuation

E

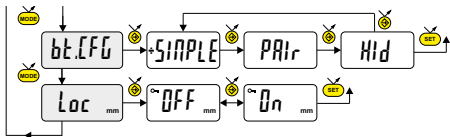



Bluetooth® profile selection (depending on model, see chap. 6 for details). The + sign indicates the currently active profile.

Keypad lock, Only the DATA and CLR functions of the favorite key remains actives. (to unlock the keypad, press SET for 5 sec.

5. Work in MINIMUM, MAXIMUM and DELTA (TIR) modes :

In this operating mode, the digital display stores the MIN, MAX or DELTA value. On the other hand, the analogue scale always indicates the current measured value.

- A short press on  resets the MIN/MAX stored value (CLEAR)
- A long press (>2s) on  assigns the Preset value to the position of current measurement.



6. Inputting (or modifying) tolerance limits

The tolerance limits are defined by introducing lower and upper intervals, compared to the nominal rating. Two methods are available:

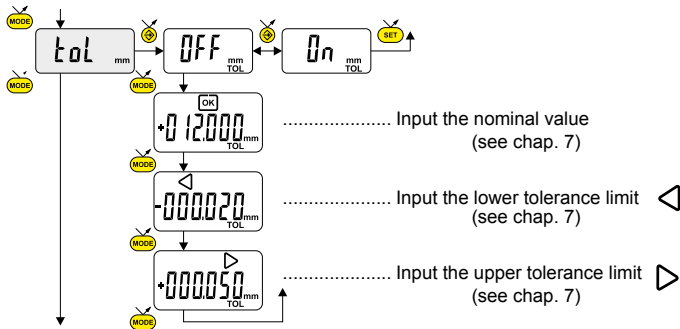
6.1 Using the TOL mode



6.2 Use of the buttons and :

It is also possible to enter or modify the nominal value or the tolerance limits by prolongedly pressing (>2s) the  and / or  button:

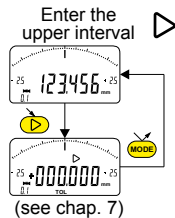
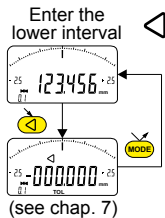
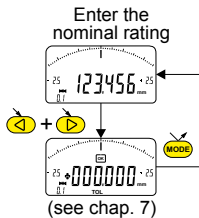

Note :

- It is also possible to display the tolerance limits when the instrument is operating in MIN, MAX or DELTA (TIR) mode.
- If no tolerance limits have been defined by the user, the instrument will only display the tolerance limit indicators but will not turn on the indicator lights (red - green - yellow).
- In case of measuring internal ratings, you can cross the indicators (red and yellow) by reversing the order of entering the tolerance intervals (upper interval < lower interval).

E**7 Entering a numeric value**

To enter or modify a numeric value (Preset, nominal ratings, tolerance intervals or multiplication factor), you can proceed in two ways:

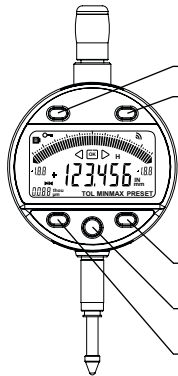
**7.1 Increases / decreases the current value :**



- ◀ Decreases the current value
- ▶ Increases the current value

Note: - the scanning speed increases with a long press on the button
- save the value with one of the three lower buttons



7.2 Entering digit by digit :

- SET Increase of the selected digit
- ↻ Selection of the next digit
- MODE Save the value

8. Scale the analog display

The user may change the analogue display's scale value by shortly pressing  or .

8.1 Centring function of the analogue scale

When the tolerance limits are asymmetric with respect to the nominal ratings, it is possible to realign them to the analogue scale, by a short simultaneous press on  and .

Example: $12.000 \begin{matrix} +0.025 \\ +0.020 \end{matrix}$

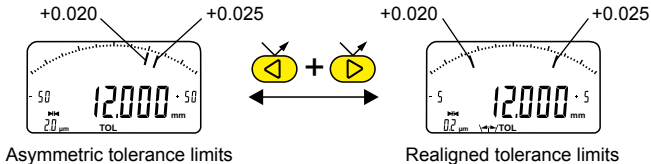

9. *Bluetooth*[®] configuration (depending on model)

The connection procedure has been designed to be simple and is signalled by the following three states:

Symbol  off disconnected mode

Symbol  blinking..... advertising mode

Symbol  on..... connected mode

The following options can be selected to control the *Bluetooth*[®] module.

OnEnable *Bluetooth*[®] module (start advertising mode).

OFFDisable *Bluetooth*[®] module (terminate active connection).

rESEtClear pairing information.

MACDisplay the MAC (Media Access Control) address.

Three *Bluetooth*[®] profiles are available.

SiMPLE.....Profile without pairing (default).

PAIR.....Paired and secured profile.

Hid.....Virtual keyboard mode (compatible with recent equipment without driver installation).

Note:

- *Bluetooth*[®] pairing information is cleared when the profile is changed.

Connection :

- 1° Activate *Bluetooth*® compatible software and hardware (Master : PC, Display Unit).
- 2° Start the instrument. By default the *Bluetooth*® module is active and the instrument is available for connection (advertising mode).
- 3° If no connection is established during the advertisement period reactivate the *Bluetooth*® module using the *bt / On* menu.
- 4° Instrument is ready to communicate (connected mode.)

Only with paired profile :

Pairing with master is automatically done at first connection.

To connect the instrument to a new master (new pairing), pairing information on the instrument must be cleared using the *bt / reset* menu.

9.1 *Bluetooth*® specifications



Frequency Band	2.4GHz (2.402 - 2.480GHz)
Modulation	GFSK (Gaussian Frequency Shift Keying)
Max Output Power	Class 3: 1mW (0dBm)
Range	Open space: up to 15m Industrial environment: 1-5m
Battery life	Continuous : up to 2 months (Always connected with 4 values /sec) Saver : up to 5 months (The instrument sends value only when the position has changed) Blind/Push : up to 7 months (Value is sent from the instrument (button) or requested from the computer)

Other specifications on the manufacturer's website

10. Favourite key

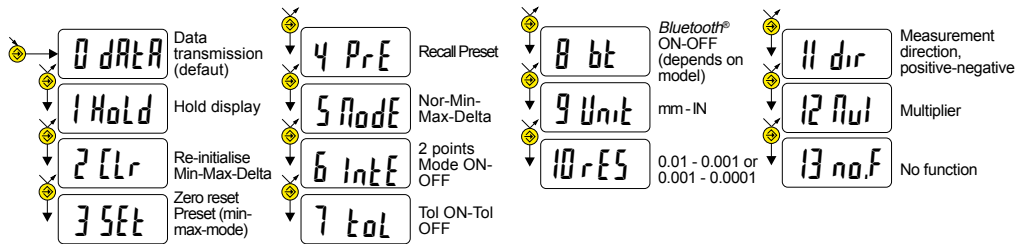
The «favourite» key gives direct access to a predefined function, and can be configured according to the needs of the user. In order to assign a function to the «favourite» key, give a prolonged press on , and then select the required function:



Validation of selection: By a prolonged press on  or a short press on  or 

Note: a function can also be assigned via RS232 using the command <FCT + Function No.>
example: Change of Unit = <FCT9>, reverse the measurement direction = <FCTB>

11. Adjustment and use of *IntE* dynamic measuring mode

Certain applications need to adjust the instrument to the MIN (or MAX) measured value. In this case, proceed as follows :

11.1 Adjustment of the instrument

- Enter a Preset value corresponding to the actual size of the standard (see chap. 3)
- In the *IntE* menu, select the mode -AMIN (automatic selection of DIR- and mode MIN) or +AMIN (automatic selection of DIR+ and mode MIN) or +AMAX (automatic selection of DIR+ and mode MAX) depending on application
- Make a standard measurement (going through the turnaround point)
- Adjust the instrument by selecting the *SEt* mode and pressing on the button  (see chap. 3)
- The instrument is adjusted and ready to measure.

11.2 Measure

- Make the measurements going through the turnaround point. The digital display stores and displays the MIN (or MAX) measured value.
- Before each new measurement, reset the measured value by a short press on 

Examples :

+ Amin
MEASURING

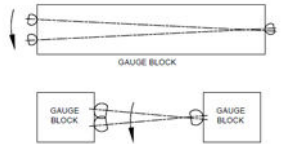

- Amin
MEASURING



+ Amax
MEASURING

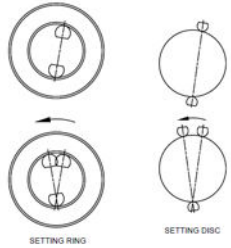

12. Switching off

The dial gauge goes automatically into stand-by if not used for 10 minutes, unless Auto OFF mode has been turned off (see Chap. 4, Second level functions)

Stand-by mode can be forced by a prolonged press (> 2 sec) on



In stand-by mode, the value of the origin is retained by the sensor (SIS mode), and the instrument automatically restarts with any movement of the measurement probe, RS command, *Bluetooth*[®] request or press of a button.

The instrument can be switched off completely for a long period of non-use, but this will necessitate a zero reset on restart (the origin will be lost):



13. Re-initialising the instrument

The initial instrument settings can be restored at any time by a prolonged press (>4 sec) simultaneously on

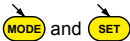

until the message *reset* is displayed.

14. Personalising the instrument

Access to the functions of your instrument can be personalised, for more information see manufacturer's website (requires you to connect your instrument via a Proximity or Power RS / USB cable).

Possibilities:

- Enable or disable the required functions
- Modify access to the Second level functions (direct access)

15. Connecting the instrument

The instrument can be connected to a peripheral via a Proximity (RS or USB), Power (RS or USB) cable, or *Bluetooth*[®]. See page 2 for connecting the Power cable.

Measured values can be transmitted and the instrument driven using predefined retro-commands (see chap. 16 for a list of the main commands)

Note :

In Tolerance mode, the tolerance limit lights remain lit only for a few seconds while the measurement stabilises. On the other hand, they will remain lit continuously if the instrument is connected to, and powered by, the Power RS (USB) cable.

16. List of the main commands

Selection and configuration

CHA+ / CHA-	Change measurement direction
FCT0 ...9...A...F	Assign «favourite» function
MM / IN	Change measurement unit
KEY0 / KEY1	Lock / unlock keypad
MUL [+/-]xx.xxxx	Modification of the multiplier
PRE [+/-]xxx.xxx	Modify preset value
STO1 / STO0	Activate / de-activate HOLD
TOL1 / TOL0	Activate / de-activate tolerances
ECO1 / ECO 0	Activate / de-activate economic mode
INTE1 / INTE0	2 points measurement mode
LCAL dd.mm.yy	Modify last calibration date
NCAL dd.mm.yy	Modify next calibration date
NUM x...x (up to 20 chars)	Modify the instrument number
TOL +/-xxx.xxx +/-yyy.yyy +/-zzz.zzz	Inputting nominal and current tolerance limits
MIN /MAX /DEL /NOR	Selecting MIN, MAX, Delta, Normal mode
CLE	Re-initialisation of MIN, MAX or Delta
UNI1 / UNIO	Activate / de-activate change of units
OUT1 /OUT0	Activate / de-activate contin. data transmission
PRE ON / PRE OFF	Activate / de-activate Preset function
PRE	Recall Preset
SET	Zero reset
RES1 / RES2 / RES3	Change of resolution
AOFF	Activates/deactivates the automatic switch-off
CFGBAR NOR MAX	Keep Bargraph on Max value
SBY xx	xx number of minutes before stand-by

Bluetooth®

BT0/BT1	Activate/de-activate <i>Bluetooth</i> ® module
BTRST	Reset pairing information

Interrogation

CHA?	Measurement sense?
FCT?	«favourite» function active?
UNI?	Measurement unit active?
KEY?	Keypad locked?
MUL?	Multiplier value
PRE?	Preset value?
STO?	Status of HOLD function?
TOL?	Current tolerance limit values?
ECO?	Current economic mode
INTE ?	2 points mode ?
LCAL?	Date of last calibration?
NCAL?	Date of next calibration?
NUM?	Instrument number?
?	Current value (mode Tol, value followed by <=>)
MOD?	Active mode (MIN, MAX, Delta or Normal)?
SET?	Main instrument parameters?
ID?	Instrument identification code?

Maintenance functions

BAT?	Battery status (BAT1 = OK, BAT0 = low battery)
OFF	Switch-off (wake up using a button or RS)
RST	Re-initialisation of the instrument
SBY	Put instrument in stand-by (SIS)
VER?	Version No. and date of firmware
CFGBAR?	Bargraph configuration

MAC?	<i>Bluetooth</i> ® MAC address?
------	---------------------------------

17. Specifications



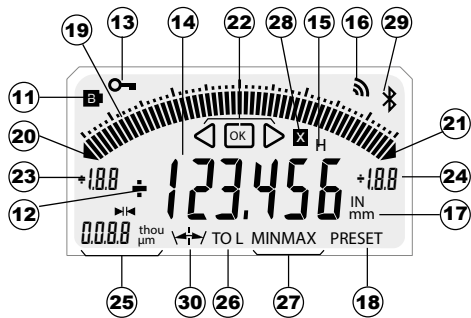
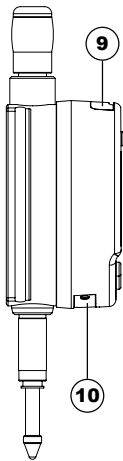
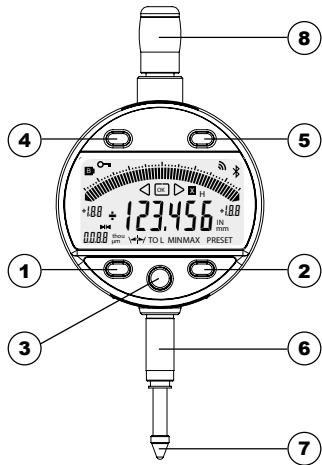

Measurement range:	12.5mm	25mm	
Max error (10µm Resolution):	10µm	10µm	(±1 digit)
Max error (1µm Resolution):	3µm	4µm	
Max error (0.1µm Resolution):	1.8µm	2.2µm	
Repeatability:		2µm	
Weight:	119g	123g	
Measurement force (standard):	0.65-0.9N	0.65-1.15N	
Max. speed of travel:		1.7m/s	
No. of measurements/ sec:	measurement: 10 meas/s MIN/MAX mode: 20 meas/s		
Measurement unit:	metric/english (Inch)		
Maximum Preset (10µm Resolution):	±9999.99 mm / ±399.9995 IN		
Maximum Preset (1µm Resolution):	±999.999 mm / ±39.99995 IN		
Maximum Preset (0.1µm Resolution):	±99.9999 mm / ±3.999995 IN		
Analogue scale value increment:	min 0.2 µm - max 1 mm / min 0.01 thou - 0.05 IN		
Analogue scale capacity:	min ±5 µm - max ±25 mm / min ± 0.25 thou - max ± 1.25 IN		
Measurement system:	Sylvac inductive system (patented)		
Power:	1 x 3V lithium battery, type CR2032, 220mAh		
Average battery life:	8'000 hours (<i>Bluetooth</i> [®] see chapter 9.1)		
Data output:	RS232/USB compatible		
Working temperature (storage):	+5 to +40°C (-10 to +60°C)		
Electromagnetic compatibility:	as per EN 61326-1		
IP rating (in accordance with IEC60529):	IP 54		
Fixing and space envelope:	Ø8h6 (3/8"), interchangeable M2.5 (4-48-UNF) probe (as per DIN 878)		

F

Description

1. Bouton MODE
2. Bouton SET
3. Bouton "Favoris"
4. Bouton ◀
5. Bouton ▶
6. Canon de fixation Ø8 ou 3/8"
7. Touche à bille Ø2/M2.5 ou 4-48-UNF
8. Bonnette de relevage
9. Logement pour câble Proximity
10. Logement batterie ou câble Power
11. Batterie faible
12. Indicateur +/-
13. Blocage du clavier (chap. 4)
14. Affichage 6 digits
15. Gel de la valeur de mesure (chap. 10)
16. Envoi de données (chap. 10)
17. Unité de mesure mm/INCH (chap. 3)
18. Mode Preset (chap. 3)
19. Echelle analogique (chap. 8)
20. Dépassement de la limite inférieur
21. Dépassement de la limite supérieur
22. Indicateur des tolérances
23. Limite inférieur échelle analogique (chap. 8)
24. Limite supérieur échelle analogique (chap. 8)
25. Unité et valeur de l'échelon analogique (chap. 8)
26. Mode tolérance actif (chap. 4)
27. Mode MIN/MAX/DELTA (chap. 4)
28. Facteur de multiplication (chap. 4)
29. Connexion *Bluetooth*® (chap. 9, dépend du modèle)
30. Tolérances symétriques (chap. 8.1)

1. Les fonctionnalités de l'instrument

-  L'instrument possède 2 modes de travail : fonctions premier niveau (avec accès direct) et fonctions second niveau. En plus des fonctions de configuration, vous pouvez accéder au mode MIN, MAX et DELTA (TIR), ou à l'affichage des Tolérances. (voir chap. 3 et 4)
-  Le bouton « favori » permet d'attribuer un accès direct à la fonction principalement utilisée (voir chap. 9)
-  Le bouton « SET » permet d'attribuer une valeur de Preset, de réinitialiser le mode MIN/MAX, de quitter une sélection, et de gérer l'extinction de l'instrument. Par défaut, le mode SIS permet l'extinction automatique sans perte de l'origine (voir chap. 11).
-  Les boutons « Gauche et Droit » permettent de modifier l'étendue de l'échelle analogique, ainsi que d'introduire les valeurs de la cote nominale et des limites de tolérances. (voir chap. 6.2)

- Personnalisation des fonctions

Vous avez la possibilité d'activer ou désactiver certaines fonctions de l'instrument par RS232 (voir chap. 13)

- Paramètres de transmission de données

4800Bds, 7 bits, parité paire, 2 stop bits

2. Démarrer

Presser un bouton. (pour une connexion *Bluetooth*[®], voir chapitre 9)

3. Fonctions premier niveau

Chaque pression courte sur **MODE** permet un accès direct aux fonctions premier niveau :

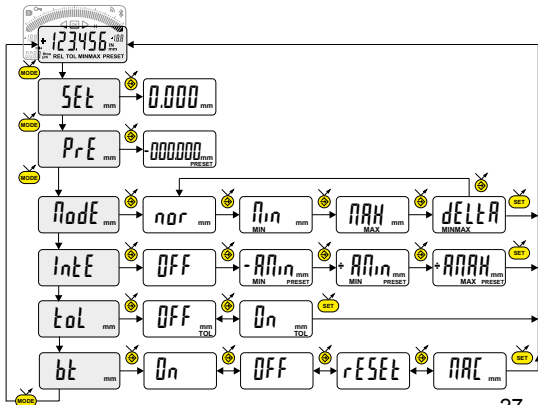

- Mode normal: Mise à zéro
 - Mode min (max): Préréglage sur la valeur min (max) mesurée
- Introduction d'une valeur de Preset (voir chap. 7)

Mesure du MINIMUM, MAXIMUM et DELTA (TIR) (voir chap. 5)

Mesure 2 points (preset dynamique) (voir chapitre 11)

Affichage des tolérances (introduction des limites de tolérances (voir chap. 6)

Bluetooth® (selon version). Activation /désactivation, réinitialisation du module Bluetooth® ou affichage de l'adresse MAC.

4.fonctions second niveau

Une pression longue (>2s) sur **MODE** permet d'accéder aux fonctions second niveau. Puis, chaque pression courte sur **MODE** accède à la fonction souhaitée :

F

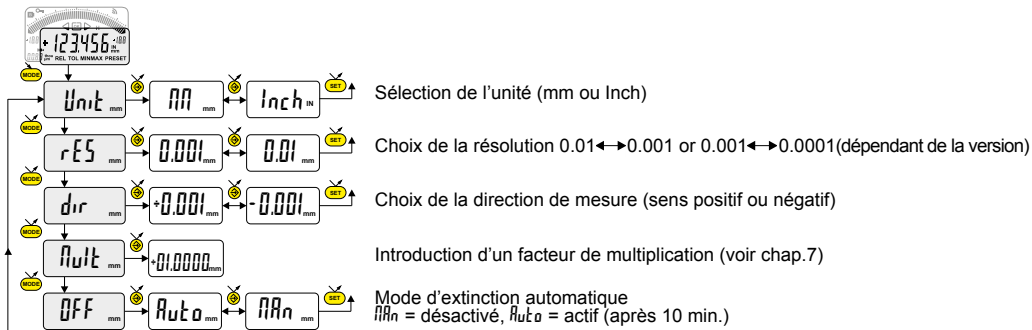

..... suite

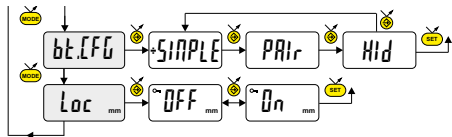



Sélection du profil *Bluetooth*[®] (dépendant de la version). (Voir chap. 6 pour plus de détails). Le symbole + indique le profil actif.

Blocage du clavier Seules les fonctions DATA et CLR de la touche favori restent actives (pour désactiver le blocage du clavier, presser SET pendant 5 s.)

F

5. Travail en mode MINIMUM, MAXIMUM et DELTA (TIR) :

Dans ce mode d'utilisation, l'affichage digital mémorise la valeur MIN, MAX ou DELTA. Par contre l'échelle analogique indique toujours la valeur courante mesurée.

- Une pression courte sur  réinitialise la valeur MIN/MAX mémorisée (CLEAR)
- Une pression longue (>2s) sur  attribue la valeur Preset à la position de mesure actuelle.

6. Introduction (ou modification) des limites de tolérances

Les limites de tolérances sont définies en introduisant l'écart inférieur et supérieur, par rapport à la cote nominale. Deux méthodes sont possibles :

6.1 Utilisation du mode TOL

F

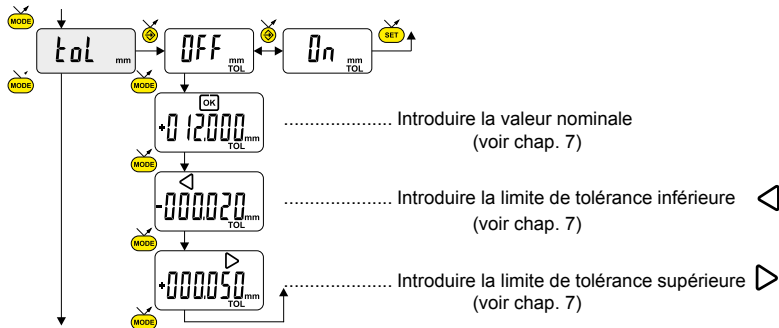

6.2 Utilisation des boutons ◀ et ▶ :

Il est également possible d'introduire ou de modifier indépendamment la valeur nominale ou les écarts inférieur et supérieur, par une pression longue (>2s) sur ◀ et/ou ▶ :

Introduire la cote nominale

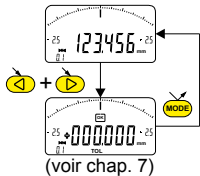

Introduire l'écart inférieure ◀

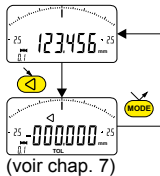

Introduire l'écart supérieure ▶

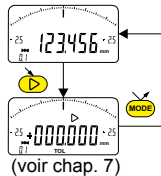

Note :

- Il est également possible d'afficher les limites de tolérance lorsque l'instrument travaille en mode MIN, MAX ou DELTA (TIR).
- Si aucune limites de tolérance n'ont été définies par l'utilisateur, l'instrument affichera les indicateurs de limites de tolérances , mais sans activer les indicateurs lumineux (rouge - vert - jaune)..
- Dans le cas de mesure de cotes d'intérieur, on peut croiser les indicateurs (rouge et jaune) en inversant l'ordre d'introduction des écarts de tolérances (écart supérieur < écart inférieur).

7 Introduction d'une valeur numérique

Pour introduire ou modifier une valeur numérique (Preset, cote nominale, écarts de tolérances ou facteur de multiplication), on peut procéder selon deux méthodes :

F

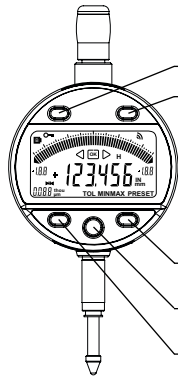

7.1 Incrément / décrémentation de la valeur actuelle:



- ◀ Décrémente la valeur actuelle
- ▶ Incrémente la valeur actuelle

Note: - la vitesse de balayage augmente lors d'une pression prolongée du bouton
- sauve la valeur avec l'un des trois boutons inférieurs



7.2 Introduction digit par digit:

- SET Incrémentation du digit sélectionné
- ↻ Sélection du prochain digit
- MODE Sauve la valeur

8. Echelle de l'affichage analogique

Une pression courte sur  ou , permet de modifier la valeur d'échelon de l'affichage analogique.

8.1 Fonction de centrage de l'échelle analogique

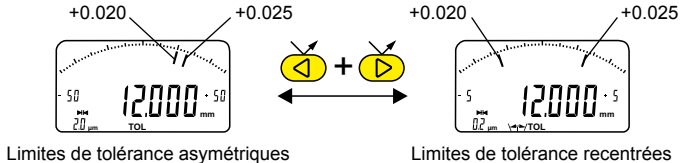

Lorsque les limites de tolérances sont asymétriques par rapport à la cote nominale, il est possible de les recentrer sur l'échelle analogique, par une pression courte simultanée sur  et .

Exemple: $12.000 \begin{matrix} +0.025 \\ +0.020 \end{matrix}$



9. Configuration *Bluetooth*[®] (selon modèle)

La procédure de connexion a été pensée au plus simple et se distingue par les 3 états ci-dessous:

- Symbole  éteint mode déconnecté.
- Symbole  clignote mode découverte.
- Symbole  allumé mode connecté.

F

Les options suivantes peuvent être sélectionnées pour contrôler le module *Bluetooth*[®].

- On** Activer le module *Bluetooth*[®] (démarrer le mode découverte).
- OFF** Désactiver le module *Bluetooth*[®] (terminer la connexion active).
- rESEt** Effacer les informations d'appairage.
- MAC** Afficher l'adresse MAC (Media Access Control).

Trois profils *Bluetooth*[®] sont disponibles.

- SIMPLE** Profil non appairé (par défaut).
- PAIR** Profil appairé et sécurisé.
- Hid** Mode clavier virtuel (compatible avec un équipement récent sans installation d'un pilote).

- Remarque:

Les informations d'appairage *Bluetooth*[®] sont effacées lorsque le profil est modifié.

Connexion :

- 1° S'assurer que l'application et le matériel *Bluetooth*[®] compatibles sont actifs (PC, unité de mesure).
- 2° Démarrer l'instrument. Par défaut le module *Bluetooth*[®] est actif et l'instrument est connectable (mode découverte).
- 3° Dès que l'instrument est détecté la connexion est automatique. Si la connexion n'a pas été établie pendant que l'instrument se trouvait en mode découverte, réactiver le module *Bluetooth*[®] via le menu *bt / On*.
- 4° L'instrument est prêt à transmettre (mode connecté).

Seulement avec le profil d'appairage :

L'appairage de l'instrument avec le maître se fait automatiquement à la première connexion.

Pour connecter un instrument à un nouveau maître (nouvel appairage), les informations d'appairage doivent être effacées via le menu *bt / rESt*.



9.1 Spécification *Bluetooth*[®]

Bande de fréquence	2.4GHz (2.402 - 2.480GHz)
Modulation	GFSK (Gaussian Frequency Shift Keying)
Puissance de sortie max.	Classe 3: 1mW (0dBm)
Portée	Espace ouvert : jusqu'à 15m Environnement industriel : 1-5m
Autonomie	Continuous : Jusqu'à 2 mois - Toujours connecté avec 4 valeurs /sec. Saver : jusqu'à 5 mois - L'instrument envoie la valeur quand la position change. Blind/Push : jusqu'à 7 mois - La valeur est envoyée de l'instrument (bouton) ou demandée par ordinateur.



Autre spécifications sur le site du fabricant.

10. Touche favori

La touche « favori » permet l'accès direct à une fonction prédéfinie et peut être configurée selon les besoins de l'utilisateur.

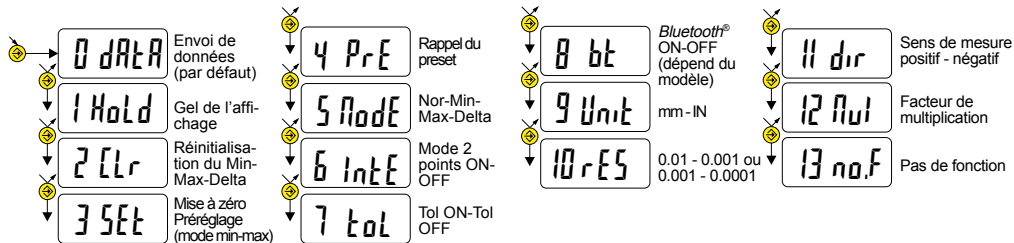
Pour attribuer une fonction à la touche « favori », effectuer une pression longue (>2s) sur , puis sélectionner la fonction souhaitée :



Validation de la sélection : Par une pression longue sur  ou une pression courte sur  ou 

Remarque : l'attribution de la fonction peut également se faire par RS 232, avec la commande <FCT + N° de fonction>
exemple : Changement d'unité = <FCT9>, inverser la direction de mesure = <FCTB>

11. Réglage et utilisation du mode de mesure dynamique *IntE*

Certaines applications nécessitent un ajustage de l'instrument sur la valeur MIN ou MAX mesurée. Dans ce cas, il faut procéder comme suit :

F

11.1 Réglage de l'instrument

- Introduire une valeur de Preset correspondant à la dimension effective de l'étalon (voir chap. 3)
- Dans le menu *IntE*, sélectionnez le mode -AMIN (sélection automatique du DIR- et du mode MIN) ou +AMIN (sélection automatique du DIR+ et du mode MIN) ou +AMAX (sélection automatique du DIR+ et du mode MAX) dépend de l'application.
- Effectuer une mesure de l'étalon (en passant par le point de rebroussement)
- Ajuster l'instrument, en sélectionnant le mode *Set* et en pressant sur le bouton  (voir chap. 3)
- L'instrument est ajusté, et prêt à mesurer.

11.2 Mesure

- Effectuer les mesures en passant par le point de rebroussement. L'affiche digital mémorise et affiche la valeur MIN (ou MAX) mesurée.
- Avant chaque nouvelle mesure, réinitialiser la valeur mesurée par une pression courte sur 

Exemples :

+ A_{min}
MEASURING

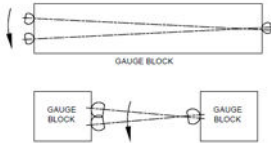

- A_{min}
MEASURING



+ A_{max}
MEASURING

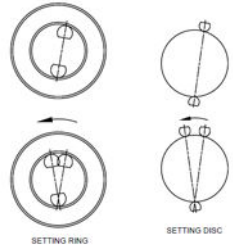

F

12. Extinction

Le comparateur se met automatiquement en stand-by après 10 minutes de non utilisation, sauf si le mode Auto OFF est désactivé (voir chap.4, fonctions second niveau)

Vous pouvez forcer le mode stand-by, par pression longue (>2s) sur  :

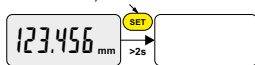

En mode stand-by, la valeur d'origine est conservée par le capteur (mode SIS), et l'instrument redémarre automatiquement par un mouvement de la touche de mesure ainsi que par commande RS, *Bluetooth*[®] ou par pression sur un bouton.

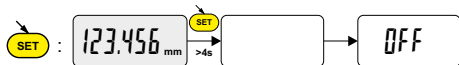

Il est possible d'éteindre complètement l'instrument pour une longue période de non utilisation, mais cela nécessitera une remise à zéro à l'enclenchement (perte de l'origine):

- Effectuer une pression longue (>4s) sur



13. Réinitialisation de l'instrument

A tout moment, il est possible de restaurer les réglages initiaux de l'instrument, par une pression longue (>4s) simultanée

sur  et  jusqu'à l'affichage du message *rESt*.

14. Personnalisation de l'instrument

Il est possible de personnaliser l'accès aux fonctions de votre instrument, pour plus d'information voir site-web du fabricant (nécessite une connexion de votre instrument, via un câble Proximity ou Power RS / USB).

Possibilités :

- Désactiver ou activer les fonctions souhaitées
- Modifier l'accès aux fonctions second niveau (mise en accès direct)

F

15. Connexion de l'instrument

L'instrument peut être connecté à un périphérique, via un câble Proximity (RS ou USB), ou Power-RS (Power-USB) ou *Bluetooth*®. Voir en page 2 pour la connexion des câbles.

Possibilité de transmettre les valeurs mesurées, et piloter l'instrument à l'aide de rétro-commandes prédéfinies (liste des commandes principales, voir chap.16)

Remarque :

En mode Tolérance, les indicateurs lumineux des limites de tolérances ne restent allumés que quelques secondes lorsque la mesure est stabilisée. Par contre, ils resteront allumés en permanence si l'instrument est connecté et alimenté par le câble Power RS (USB).

16. Liste des commandes principales

Sélection et configuration

CHA+ / CHA-	Changement direction de mesure
FCT0 ...9...A...F	Attribution fonction «favori»
MM / IN	Changement unité de mesure
KEY0 / KEY1	Active / désactive le blocage clavier
MUL [+/-]xx.xxxx	Modification du facteur de multiplication
PRE [+/-]xxx.xxx	Modification valeur de preset
STO1 / STO0	Active / désactive le HOLD
TOL1 / TOL0	Active / désactive les tolérances
ECO1 / ECO0	Active / désactive le mode économique
INTE1 / INTE0	Mode de mesure 2 points
LCAL dd.mm.yy	Modifie date dernière calibration
NCAL dd.mm.yy	Modifie date prochaine calibration
NUM x...x (jusqu'à 20 car.)	Modifie le numéro de l'instrument
TOL +/-xxx.xxx +/-yyy.yyy +/-zzz.zzz	Introduction nominale et limites de tolérances actuelles
MIN / MAX / DEL / NOR	Sélection mode MIN, MAX, Delta, Normal
CLE	Réinitialisation du MIN, MAX ou Delta
UNI1 / UNIO	Active / désactive le changement d'unité
OUT1 / OUT0	Active / désact. transmission données en continu
PRE ON / PRE OFF	Active / désact. la fonction Preset
PRE	Rappel du Preset
SET	Mise à zéro
RES1 / RES2 / RES3	Changement résolution
AOFF	Activates/deactivates the automatic switch-off
CFGBAR	XXX
CFGBAR NOR MAX	Garde le bargraphe en valeur max.
SBY xx	xx nombre de minutes avant stand-by

Bluetooth®

BT0/BT1	Activer/désactiver le module Bluetooth®
BTRST	Reset des informations d'appairage

Interrogation

CHA?	Sens de mesure?
FCT?	Fonction «favori» active?
UNI?	Unité de mesure active?
KEY?	Blocage clavier?
MUL?	Valeur du facteur de multiplication
PRE?	Valeur de preset?
STO?	Etat fonction HOLD?
TOL?	Valeur des limites de tol actuelles?
ECO?	Mode économique courant
INTE ?	Mode 2 points ?
LCAL?	Date dernière calibration?
NCAL?	Date prochaine calibration?
NUM?	Numéro de l'instrument?
?	Valeur actuelle? (mode Tol, valeur suivie de <=>)
MOD?	Mode actif (MIN, MAX, Delta ou Normal)?
SET?	Paramètres principaux de l'instrument?
ID?	Code d'identification de l'instrument?

Fonctions de maintenance

BAT?	Etat pile (BAT1=Ok, BAT0=pile faible)
OFF	Extinct. complète (réveil par bouton ou RS)
SBY	Mise en Stand by de l'instrument (SIS)
VER?	Révision et date du firmware
CFGBAR?	Configuration du bargraphe
MAC?	Bluetooth® MAC address?

17. Spécifications

Etendue de mesure:	12.5mm	25mm	
Erreur max (résolution 10µm):	10µm	10µm	(±1 digit)
Erreur max (résolution 1µm):	3µm	4µm	
Erreur max (résolution 0.1µm):	1.8µm	2.2µm	
Répétabilité:		2µm	
Poids:	119g	123g	
Force de mesure (standard):	0.65-0.9N	0.65-1.15N	
Vitesse max. de déplacement:		1.7m/s	
Nbre de mesure par seconde:		mesure: 10 mes/s	mode MIN/MAX: 20 mes/s
Unité de mesure:		métrique/anglaise (Inch)	
Preset maximum (résolution 10µm):		±9999.99 mm / ±399.9995 IN	
Preset maximum (résolution 1µm):		±999.9999 mm / ±39.99995 IN	
Preset maximum (résolution 0.1µm):		±99.999 mm / ±3.999995 IN	
Valeur échelon échelle analogique		min 0.2 µm - max 1 mm / min 0.01 thou - 0.05 IN	
Capacité échelle analogique		min ±5 µm - max ±25 mm / min ± 0.25 thou - max ± 1.25 IN	
Système de mesure:		Sylvac inductive system (breveté)	
Alimentation:		1 batterie lithium 3V, type CR2032, capacité 220mAh	
Autonomie moyenne:		8'000 heures (Bluetooth® voir chapitre 9.1)	
Sortie de données:		compatible RS232 / USB	
Température de travail (stockage):		+5 à +40°C (-10 à +60°C)	
Compatibilité électromagnétique:		selon EN 61326-1	
Spécification IP (selon IEC60529):		IP 54	
Fixation et encombrement:		fixation Ø8h6 (3/8"), touche de mesure interchangeable M2.5 (4-48-UNF) (selon DIN 878)	



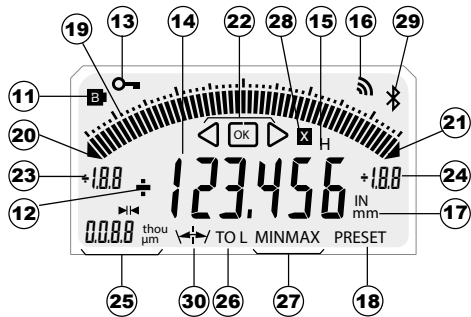
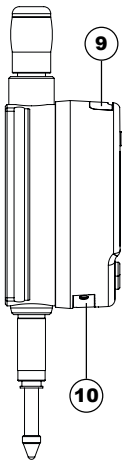
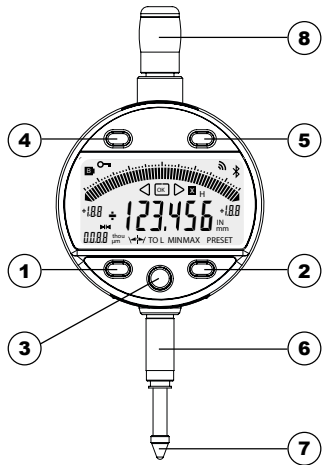

F

D

Beschreibung

1. MODE-Taste
2. SET-Taste
3. Favoriten-Taste
4. ◀ Taste
5. ▶ Taste
6. Einspannschaft Ø8 oder 3/8"
7. Kugeltaster Ø2/M2.5 oder 4-48-UNF
8. Abhebekapsel
9. Buchse für Proximity Kabel
10. Batterieeinschub oder Netzkabelbuchse
11. Batterie schwach
12. +/- Anzeige
13. Tastatursperre (Kap. 4)
14. Anzeige von 6 Ziffern
15. Festhalten des Messwerts (Kap. 10)
16. Datenübertragung (Kap. 10)
17. Masseinheit mm/INCH (Kap. 3)
18. Preset-Modus (Kap. 3)
19. Strichskala (Kap. 8)
20. Unterer Grenzwert unterschritten
21. Oberer Grenzwert überschritten
22. Toleranzanzeiger
23. Unterer Grenzwert Strichskala (Kap. 8)
24. Oberer Grenzwert Strichskala (Kap. 8)
25. Einheit und Skalenteilungswert (Kap. 8)
26. Toleranz-Modus (Kap. 4)
27. MIN/MAX/DELTA-Modus (Kap. 4)
28. Multiplikator (Kap. 4)
29. *Bluetooth*® Anschluss (Kap.9, nach Modell)
30. Symmetrische Toleranzen (Kap. 8.1)

1. Funktionalitäten des Instruments:

-  Das Instrument verfügt über zwei Betriebsarten: die Funktionen der ersten Ebene (mit direktem Zugang) und die Funktionen der zweiten Ebene. Neben den Konfigurationsfunktionen hat man Zugriff auf die Modi MIN, MAX und DELTA (TIR), oder auf die Toleranzanzeige. (siehe Kap. 3 und 4).
-  Mit der Taste „Favoriten“ kann man der hauptsächlich verwendeten Funktion einen direkten Zugriff zuzuweisen (siehe Kap. 9).
-  Ermöglicht die Zuweisung eines Presetwertes, die Reinitialisierung der Modi MIN/MAX, die Quittierung einer Auswahl und die Steuerung des Ausschaltens des Instruments. Der SIS-Modus ermöglicht standardmässig das automatische Ausschalten ohne Verlust der Anfangseinstellung (siehe Kap. 11).
-   Über die Tasten «Links» und «Rechts» wird der Bereich der Strichskala geändert sowie Nominalwert und Toleranzgrenze eingegeben.(siehe Kap. 6.2)

- Personalisierung der Funktionen

Es ist möglich, einige Funktionen des Instruments über R232 zu aktivieren oder zu deaktivieren (siehe Kap.13)

- Parameter für Datenübertragung

4800Bds, 7 Bits, gerade Parität, 2 Stoppbits

2. Starten

Eine Taste drücken. Zur *Bluetooth*[®]-Verbindung (siehe Kap. 9).

3. Funktionen erste Ebene

Jede kurze Betätigung von **MODE** ermöglicht einen direkten Zugriff auf die Funktionen der ersten Ebene:

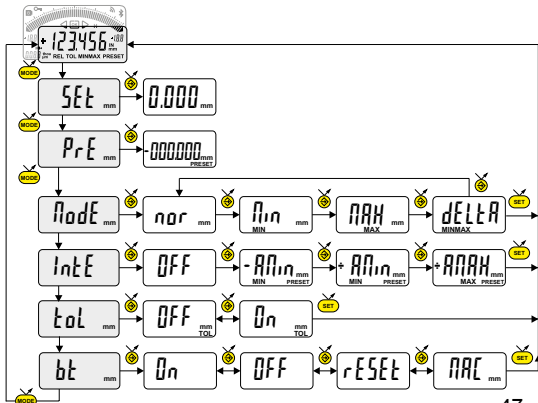

Normalmodus: Nullen
Min-(Max-)Modus: Voreinstellung auf gemessenem Min-(Max-)Wert
Eingabe des Presetwertes (siehe Kap. 7)

Messen von MINIMUM, MAXIMUM, DELTA (TIR)
(siehe Kap. 5)

2 Punkte Modus (Dynamische Preset) (siehe Kap. 11)

Anzeige der Toleranzen
(Eingabe der Toleranzgrenzen, siehe Kap. 6)

Bluetooth® (versionsabhängig) Bluetooth®-Modul ein-, ausschalten, zurücksetzen oder seine MAC-Adresse anzeigen.

D

4. Funktionen zweite Ebene

Eine lange Betätigung (>2s) von **MODE** ermöglicht es, auf die Funktionen der zweiten Ebene zuzugreifen.

Anschließend führt jede kurze Betätigung von **MODE** zur gewünschten Funktion:

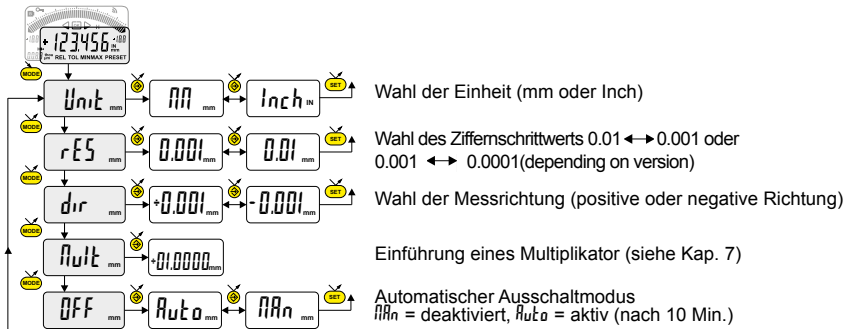

..... Fortsetzung

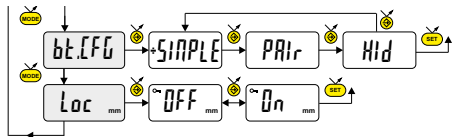

Auswahl des *Bluetooth*[®]-Profils (versionsabhängig). (Siehe Kap. 6 für weitere Informationen). Das + Symbol markiert die aktuelle Auswahl.

Tastatursperre. Nur die DATA und CLR Funktionen des Favoriten-Taste bleibt aktiv

D

5. Arbeiten im Modus MINIMUM, MAXIMUM und DELTA (TIR)

In diesem Modus speichert die Ziffernanzeige den Wert für MIN, MAX oder DELTA. Die Strichskala gibt jedoch immer den aktuellen Messwert an.

- Ein kurzer Druck auf **SET** setzt den gespeicherten MIN/MAX-Wert zurück (CLEAR).
- Mit einem langen Druck (>2s) auf **SET** wird der aktuelle Messwert als Preset-Wert registriert.

6. Eingeben (oder Ändern) von Toleranzgrenzen

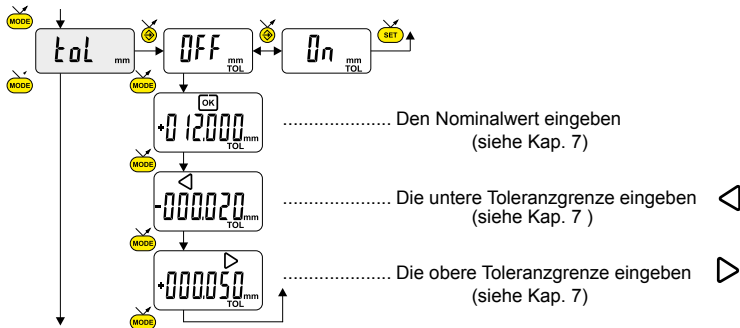

Toleranzgrenzen werden durch die Eingabe von oberen und unteren Abweichungen gegenüber dem Nominalwert festgelegt. Dies kann auf zwei Arten erfolgen:

6.1 Verwendung des Modus TOL



D

6.2 Verwendung der Tasten und :

Nominalwert oder Toleranzgrenzen können auch durch langes Drücken (>2s) der Tasten  und/oder  eingegeben oder geändert werden:

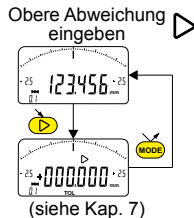
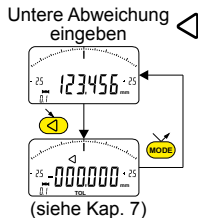
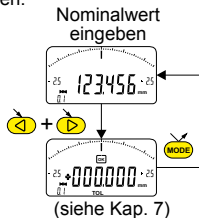

Hinweis :



- Es ist auch möglich, die Toleranzwerte anzuzeigen, wenn das Instrument in der Betriebsart MIN, MAX oder DELTA (TIR) arbeitet.
- Falls keine Toleranzgrenzen festgelegt wurden, stellt das Instrument die Toleranzgrenzanzeige dar, aber ohne die Leuchtmelder (rot – grün – gelb) zu aktivieren.
- Beim Messen von Innenmassen können die Zeiger (rot und gelb) gekreuzt werden, indem die Eingabereihenfolge der Toleranzabweichungen (obere Abweichung < untere Abweichung) vertauscht wird.

7 Eingabe von Ziffernwerten

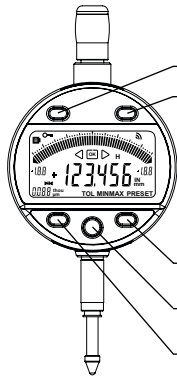
Zum Eingeben oder Ändern eines Ziffernwerts (Preset, Nominalwert, Toleranzabweichung oder Multiplikationsfaktor) bestehen zwei Möglichkeiten:





7.1 Schrittweiss Erhöhung / Reduktion des aktuellen Werts :

-  Reduziert den aktuellen Wert
-  Erhöht den aktuellen Wert

Hinweis : - Längerer Druck auf die Taste erhöht die Suchgeschwindigkeit
- Gewünschten Wert mit einer der drei unteren Tasten speichern



7.2 Eingabe des Ziffernwerts :

-  Erhöhung des gewählten Werts
-  Wahl des nächsten Werts
-  Speichern des gewünschten Werts

8. Strichskala

Ein kurzer Druck auf  oder  ändert den Teilungswert der Strichskala.

8.1 Zentrierfunktion bei Strichskala

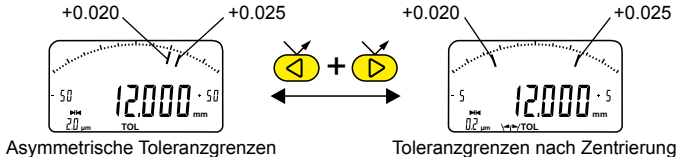

Asymmetrische Toleranzgrenzen gegenüber dem Nominalwert lassen sich bei der Strichskala durch gleichzeitigen kurzes Betätigen der Tasten  und  zentrieren.

Beispiel: $12.000 \begin{matrix} +0.025 \\ +0.020 \end{matrix}$



9. *Bluetooth*[®]-Konfiguration (je nach Modell)

Der Verbindungsaufbau ist ganz einfach und wird in 3 Zuständen angezeigt:

- Kein  Symbol keine Verbindung
- Blinkendes  Symbolbereit zur Verbindung
- Stehendes  SymbolVerbindung hergestellt

Zur Konfiguration des *Bluetooth*[®]-Moduls stehen die folgenden Optionen zur Verfügung:

- On** Aktiviert das *Bluetooth*[®]-Modul (Instrument kann gefunden werden).
- OFF** Deaktiviert das *Bluetooth*[®]-Modul (aktive Verbindung wird getrennt).
- rESEt** Hebt die *Bluetooth*[®]-Kopplung auf.
- MAC** Zeigt die MAC (Media Access Control) -Adresse an.

Drei *Bluetooth*[®]-Profile stehen zur Auswahl:

- SIMPLE** Profil ohne Kopplung.
- PAIR** Profil mit Kopplung und Verschlüsselung.
- Hid** Virtuelle Tastatur (Kompatibel mit aktuellen Geräten ohne Installation eines Treibers).

Anmerkung:

- Beim Wechsel des Profils wird die *Bluetooth*[®]-Kopplung aufgehoben.

Verbindungsaufbau :

- 1° Stellen Sie sicher, dass die *Bluetooth*[®] Anwendung und das Gerät kompatibel und aktiv sind (PC, Messeinheit).
- 2° Schalten Sie das Instrument ein. Die *Bluetooth*[®]-Funktion ist standardmässig aktiviert und das Instrument kann verbunden werden (Verbindung wird gesucht).
- 3 Wurde keine Verbindung hergestellt während das Instrument sichtbar war, aktivieren Sie *Bluetooth*[®] erneut über das Menü *bt* / *Ün*.
- 4° Das Gerät ist bereit zum Senden (Verbindung hergestellt).

Kopplung :

Die Kopplung des Instruments mit dem Master erfolgt automatisch bei der ersten Verbindung. Um das Instrument mit einem neuen Master zu verbinden (neue Kopplung), muss die Kopplung über das Menü *bt* / *rE5Et* gelöscht werden.



9.1 Technische Daten der *Bluetooth*[®]-Funktion



Frequenzband	2.4GHz (2.402 - 2.480GHz)
Modulation	GFSK (Gaussian Frequency Shift Keying)
Max. Ausgangsleistung	Klasse 3: 1mW (0dBm)
Reichweite	Im Freien: bis 15 m Industrienumgebung: 1-5 m
Autonomie	Continuous : bis zu 2 Monaten (Immer verbunden mit 4 Werten /sek). Saver : bis zu 5 Monaten (Das Gerät sendet die Werte nur wenn die Position geändert hat). Blind/Push : bis zu 7 Monaten (Der Wert wird von dem Gerät gesendet (Taste) oder vom Computer angefordert).

Weitere Spezifikationen auf der Website des Herstellers.

10. Favoriten-Taste

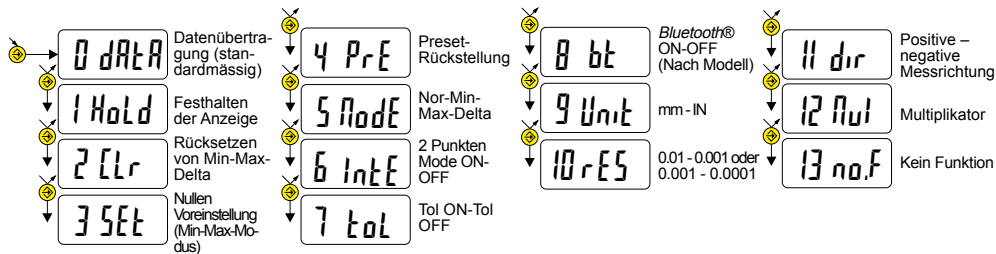
Die „Favoriten-Taste“ ermöglicht den direkten Zugriff auf eine zuvor bestimmte Funktion und kann entsprechend der Bedürfnisse des Nutzers konfiguriert werden. Um der „Favoriten-Taste“ eine Funktion zuzuordnen, muss man lange auf  drücken und dann die gewünschte Funktion wählen:



Bestätigung der Auswahl: Durch langes Drücken von  oder kurzes Drücken von  oder 

Anmerkung: Die Zuordnung der Funktion kann auch durch RS 232 erfolgen, mit der Steuerung <FCT + Funktions-Nr.>
Beispiel: Masseinheit = <FCT9>, Messrichtung wechseln = <FCTB>

11.2 Einstellung und Verwendung des dynamischen Messmodus *InLE*

Für gewisse Einsatzbereiche muss das Gerät auf die gemessenen MIN- (oder Max-) Werte justiert werden. Hierzu wird wie folgt vorgegangen :

11.1 Justieren des Geräts

- Preset-Wert gemäss effektivem Messwert des Standards eingeben (siehe Kap. 3).
- Im menü *InLE*, abhängig von der Anwendung den Modus -AMIN (automatische Auswahl des DIR- und MIN-Modus) oder +AMIN (automatische Auswahl des DIR+ und MIN-Modus) oder +AMAX (automatische Auswahl des DIR+ und MAX-Modus) hängt von der Anwendung ab.
- Standardmessung durchführen (unter Einbezug des Scheitelpunkts)
- Gerät mit Modus *SEt* und Betätigung der Taste  einstellen (siehe Kap. 3).
- Das Gerät ist nun einstellt und messbereit.

11.2 Messen

- Gewünschte Messungen unter Einbezug des Scheitelpunkts. Die Ziffernanzeige speichert und gibt die gemessenen MIN-, bzw. MAX-Werte an.
- Vor jedem Messen den Messwert durch kurzes Betätigen der Taste  zurücksetzen.

Beispielen :

+ A_{min}
MEASURING

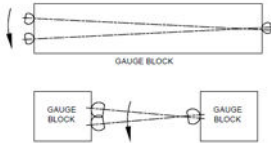

- A_{min}
MEASURING



+ A_{max}
MEASURING

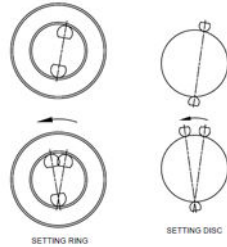

12. Ausschalten

Die Messuhr stellt sich nach 10 Minuten Nichtgebrauch automatisch auf Stand-By, außer wenn die Betriebsart Auto OFF deaktiviert ist (siehe Kap. 4, Funktionen zweiten Ebene).

Stand-By-Funktion durch langes Betätigen (>2s) von  erzwingen.

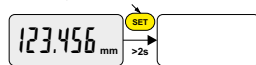



Im Stand-By-Modus wird der Referenzwert vom Sensor (SIS Modus) beibehalten und das Instrument startet automatisch mit einer Bewegung des Messeinsatzes sowie über RS, *Bluetooth*[®] Antrag oder eine Taste drücken.

Es ist möglich, das Instrument für eine lange Zeit des Nichtgebrauchs vollständig auszuschalten, aber das erfordert eine Rückstellung beim Einschalten (Verlust des Referenzwertes).

- Lange (>4s) Drücken auf  :



13. Rücksetzen des Instruments

Man kann die Werkseinstellungen des Instruments jederzeit mit einem langen (>4s), gleichzeitigen Drücken bis zur Anzeige der Meldung  auf  und  wiederherstellen.

D

14. Personalisierung des Instruments

Es ist möglich, den Zugriff auf die Funktionen Ihres Instruments mit Hilfe der kostenlosen Software zu personalisieren. Weitere Informationen finden Sie auf der Webseite des Herstellers (erfordert den Anschluss Ihres Instruments mit einem Proximity-Kabel oder RS / USB Power).

Möglichkeiten:

- die Deaktivierung oder Aktivierung der erwünschten Funktionen
- die Änderung des Zugriffs auf die fortgeschrittenen Funktionen (Schaffung eines direkten Zugriffs)

15. Anschluss des Instruments

Das Instrument kann mit einem Proximity-Kabel (RS oder USB) oder Power-RS (Power-USB) oder *Bluetooth*[®] an ein Peripheriegerät angeschlossen werden. Informationen zum Kabelanschluss finden Sie auf Seite 2

Man kann die gemessenen Werte übertragen und das Instrument mit Hilfe von bestimmten Befehlen steuern. Liste der wesentlichen Steuerbefehle, siehe Kap. 16

Anmerkung:

Im Toleranzmodus leuchten die Leuchtanzeigen der Toleranzgrenzen nur einige Sekunden, wenn die Messung stabilisiert ist. Sie bleiben jedoch ständig an, falls das Instrument durch das Power-RS- (USB-) Kabel angeschlossen ist und gespeist wird.

16. Liste der wesentlichen Steuerbefehle

Auswahl un Konfiguration Abfragen

CHA+ / CHA-	Wechsel der Messrichtung
FCT0 ...9...A...F	Zuordnung der Funktion „Favorit“
MM / IN	Wechsel der Masseinheit
KEY0 / KEY1	Aktiviert / Deaktiviert die Tastatursperre
MUL [+/-]xx.xxxx	Ändern des Multiplikator
PRE [+/-]xxx.xxx	Änderung des Presetwertes
STO1 / STO0	Aktiviert / Deaktiviert den HOLD
TOL1 / TOL0	Aktiviert / Deaktiviert die Toleranzen
ECO1 / ECO0	Aktiviert / Deaktiviert ECO Modus
INTE1 / INTE0	2 Punkte Messmodus
LCAL dd.mm.yy	Ändert das Datum der letzten Kalibrierung
NCAL dd.mm.yy	Ändert das Datum der nächsten Kalibrierung
NUM x...x (up to 20 Kar.)	Ändern Sie Instrument Nummer
TOL +/-xxx.xxx +/-yyy.yyy +/-zzz.zzz	Eingabe Nominalwert und Toleranzen
MIN / MAX / DEL / NOR	Auswahl des Modus MIN, MAX, Delta, Normal
CLE	Rücksetzen von Min, Max oder Delta
UNI1 / UNI0	Aktiviert / Deaktiviert den Einheitswechsel
OUT1 / OUT0	Aktiviert / Deaktiviert die kontinuierliche Datenübertragung
PRE ON / PRE OFF	Aktiviert /Deaktiviert die Presetfunktion
PRE	Preset-Rückstellung
SET	Nullen
RES1 / RES2 / RES3	Ändern des Ziffernschrittwerts
AOFF	Activates/deactivates the automatic switch-off
CFGBAR	xxx
CFGBAR NOR MAX	Halte Bargraph auf Maximalwert
SBY xx	Ändert die Dauer (xx Minuten) bis zum Stand-by

Bluetooth®

BT0/BT1	Activieren/deaktivieren des <i>Bluetooth</i> ® modul
BTRST	Setzen die Verbindungsinformationen

CHA?	Messrichtung?
FCT?	Funktion „Favorit“ aktiv?
UNI?	Masseinheit aktiv
KEY?	Tastatursperre?
MUL?	Multiplikator Wert
PRE?	Presetwert?
STO?	HOLD Funktionsstatus?
TOL?	Wert der aktuellen Tol.-Grenzen?
ECO?	Actueller ECO Modus
INTE ?	2 Punkte Mode ?
LCAL?	Datum der letzten Kalibrierung?
NCAL?	Datum der nächsten Kalibrierung?
NUM?	Instrument Nummer?
?	Actueller Wert (Tol.-Modus, Wert gefolgt von <=>)
MOD?	Aktiver Modus (MIN, MAX, Delta oder Normal)?
SET?	Hauptparameter des Instruments?
ID?	Identifizierungscode des Instruments?

Wartungsfunktionen

BAT?	Batteriestatus (BAT1=Ok, BAT0=Batterie schwach)
OFF	Vollständ. Ausschalten (Neuaktivierung mit Knopf oder RS)
RST	Rücksetzen des Instruments
SBY	Setzen des Instruments auf Stand-By (SIS)
VER?	Revision und Datum der Firmware
CFGBAR?	Bargraph Konfiguration
MAC?	<i>Bluetooth</i> ® MAC Adresse?

17. Technische Daten

Messbereich:	12.5mm	25mm	
Fehlergrenze (Ziffernschrittweite 10µm):	10µm	10µm	(±1 digit)
Fehlergrenze (Ziffernschrittweite 1µm):	3µm	4µm	
Fehlergrenze (Ziffernschrittweite 0.1µm):	1.8µm	2.2µm	
Wiederholbarkeit:		2µm	
Gewicht:	119g	123g	
Messkraft (Standard):	0.65-0.9N	0.65-1.15N	
Maximale Verstellgeschwindigkeit:		1.7m/s	
Anzahl der Messungen pro Sekunde:	Messung: 10 Mess/s	Betriebsart MIN/MAX: 20 Mess/s	
Masseinheit:		mm / Inch	
Maximum Preset (Ziffernschrittweite 10µm):		±9999.99 mm / ±399.9995 IN	
Maximum Preset (Ziffernschrittweite 1µm):		±999.999 mm / ±39.99995 IN	
Maximum Preset (Ziffernschrittweite 0.1µm):		±99.9999 mm / ±3.999995 IN	
Schrittweite Strichskala:	min 0.2 µm - max 1 mm / min 0.01 thou - 0.05 IN		
Messspanne Strichskala:	min ±5 µm - max ±25 mm / min ± 0.25 thou - max ± 1.25 IN		
Messsystem:	Sylvac inductive system (patentiert)		
Versorgung:	1 x 3 V Lithiumbatterie, Typ CR2032, Kapazität 220 mAh		
Durchschnittliche Autonomie:	8.000 Stunden (<i>Bluetooth</i> ® siehe Kap. 9.1)		
Datenausgang:	RS232/USB kompatibel		
Arbeitstemperatur (Lagerung):	+5 bis +40°C (-10 bis +60°C)		
Elektromagnetische Verträglichkeit:	gemäß EN 61326-1		
IP Spezifikation (gemäß IEC60529):	IP 54		
Befestigung und Platzbedarf:	Ø8h6 (3/8") Befestigung, austauschbarer M2.5 (4-48-UNF) Messeinsatz (gemäß DIN 878)		



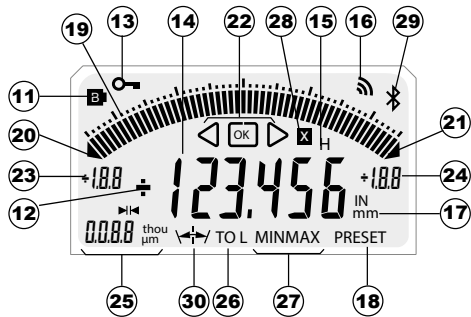
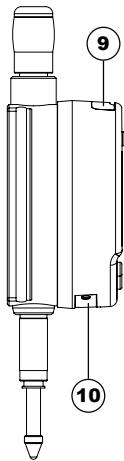
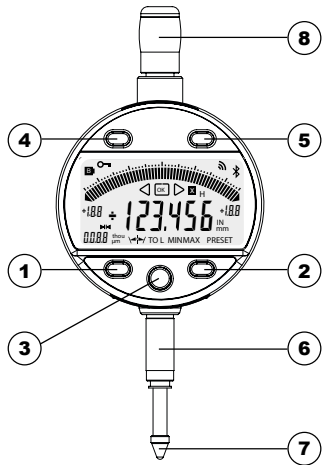

D



Descrizione

1. Pulsante Modalità
2. Pulsante Impostazione
3. Pulsante « Preferiti »
4. Pulsante ◁
5. Pulsante ▷
6. Albero di fissaggio Ø8 o 3/8"
7. Tasto a sfera Ø2/M2.5 o 4-48-UNF
8. Elemento di sollevamento
9. Alloggiamento per cavo di Proximity
10. Alloggiamento batteria o cavo di alimentazione
11. Batteria scarica
12. Indicatori +/-
13. Blocco tastiera (cap. 4)
14. Visualizzazione a 6 cifre
15. Congelamento del valore di misura (cap. 10)
16. Invio dati (cap. 10)
17. Unità di misura mm/INCH (cap. 3)
18. Modalità Preset (cap. 3)
19. Scala analogica (cap. 8)
20. Superamento del limite inferiore
21. Superamento del limite superiore
22. Indicatori di tolleranze
23. Limite superiore scala analogica (cap. 8)
24. Limite superiore scala analogica (cap. 8)
25. Unità e valore dell'intervallo analogico (cap. 8)
26. Modalità Tolleranze (cap. 4)
27. Modalità MIN/MAX/DELTA (cap. 4)
28. Fattore moltiplicativo (cap. 4)
29. Connessione *Bluetooth*[®] (dipende dal modello)
30. Tolleranze simmetriche (cap. 8.1)

1. Funzionalità dello strumento

-  Lo strumento dispone di 2 modalità operative: funzioni di primo livello (con accesso diretto) e funzioni di secondo livello. Oltre alle funzioni di configurazione, si ha accesso alla modalità MIN, MAX e DELTA (TIR), o alla visualizzazione delle tolleranze. (consultare i capitoli 3 e 4)
-  Il tasto «preferito» permette di attribuire un accesso diretto alla funzione utilizzata maggiormente (consultare il capitolo 9)
-  Permette di attribuire un valore di Preset, di reinizializzare la modalità MIN/MAX, di confermare una selezione e di gestire lo spegnimento dello strumento. Per impostazione predefinita, la modalità SIS permette lo spegnimento automatico senza perdita dell'origine (consultare il capitolo 11).
-  I tasti «destra» e «sinistra» permettono di modificare l'estensione della scala analogica e di introdurre i valori della dimensione nominale e i limiti di tolleranza (consultare il capitolo 6.2).

- Personalizzazione delle funzioni

È possibile attivare o disattivare determinate funzioni dello strumento mediante RS232 (consultare il capitolo 13)

- Parametri di trasmissione dati

4800Bds, 7 bit, parità, 2 stop bit

2. Avvio

Premere un pulsante. Per una connessione *Bluetooth*[®] (vedere il capitolo 9).

3. Funzioni di primo livello

Ogni breve pressione su **MODE** permette l'accesso diretto alle funzioni base:

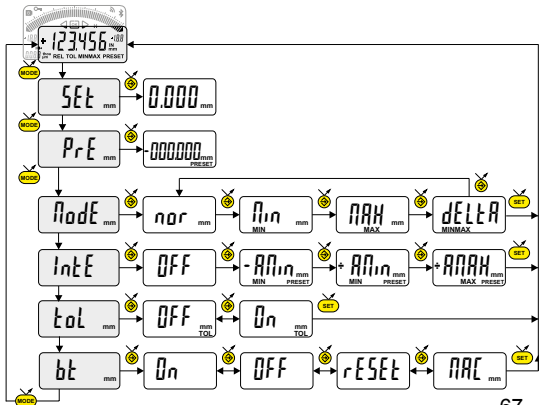

Modalità normale: Azzeramento
 Modalità min (max): Preset in base al
 valore min (max) misurato
 Inserimento di un valore di Preset (consultare il capitolo 7)

Misura del MINIMUM, MAXIMUM, DELTA (TIR) (consultare il capitolo 5)

Modalità 2 punti (preset dinamico) (vedere capitolo 11)

Visualizzazione delle tolleranze (inserimento dei limiti di tolleranza, consultare il capitolo 6)

Bluetooth® (a seconda della versione). Attivare / disattivare, reimpostazione del modulo Bluetooth® o visualizzazione dell'indirizzo MAC.

4. Funzioni di secondo livello

Una pressione lunga (>2s) su **MODE** permette di accedere alle funzioni di secondo livello.

Successivamente, ogni breve pressione su **MODE** accede alla funzione desiderata:

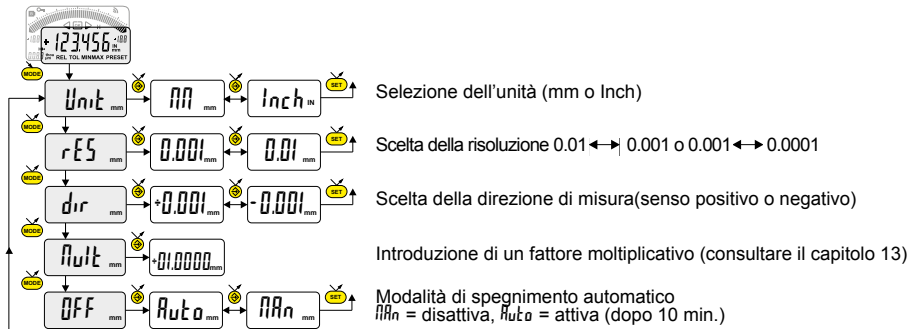

..... Segue

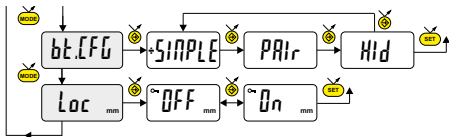

Selezione del profilo *Bluetooth*[®] (a seconda della versione).
(vedere il cap. 6 per ulteriori dettagli). Il simbolo + indica il profilo attivo.

Blocco tastiera. Solo funzioni DATA e CLR del tasto preferito rimane attivo (per disattivare il blocco tastiera, premere SET per 5 s.)

5. Lavorare in modalità MINIMUM, MAXIMUM e DELTA (TIR)

In questa modalità di utilizzo il display digitale memorizza il valore MIN, MAX o DELTA. Invece la scala analogica mostra sempre il valore corrente misurato.

- Una pressione breve su **SET** reimposta il valore MIN/MAX memorizzato (CLEAR)
- Una pressione lunga (>2s) su **SET** assegna il valore Preset alla posizione di misura attuale.

6. Introduzione (o modifica) dei limiti di tolleranza

I limiti di tolleranza si stabiliscono introducendo lo scarto inferiore e lo scarto superiore rispetto al livello nominale. Vi sono due metodi:

6.1 Utilizzo della modalità TOL

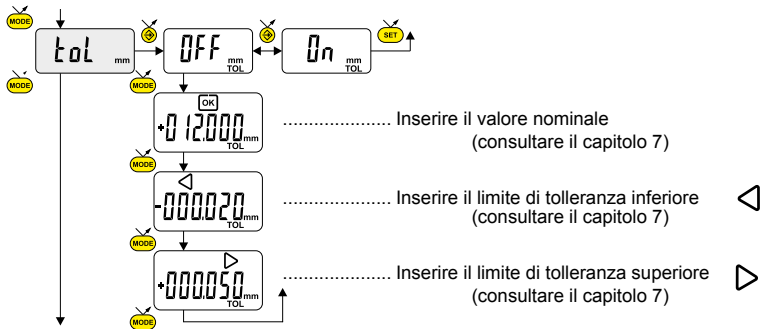

6.2 Utilizzo dei tasti ◀ e ▶ :

È possibile anche introdurre o modificare il valore nominale o i limiti di tolleranza esercitando una pressione prolungata (>2s)

sui tasti ◀ e/o ▶ :

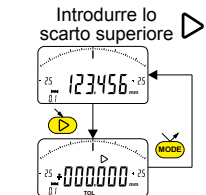
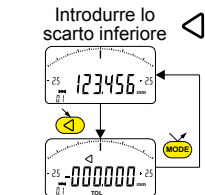
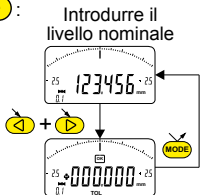

Note :



- È anche possibile visualizzare i limiti di tolleranza mentre lo strumento è in modalità MIN, MAX o DELTA (TIR)
- Se l'utente non ha definito nessun limiti di tolleranza, lo strumento visualizza gli indicatori dei limiti di tolleranze ma senza attivare le spie (rosso – verde - giallo)
- In caso di misura di livelli interni si può scambiare gli indicatori (rosso e giallo) invertendo l'ordine di inserimento degli scarti di tolleranza (scarto superiore < scarto inferiore).

7 Introduzione di un valore numerico

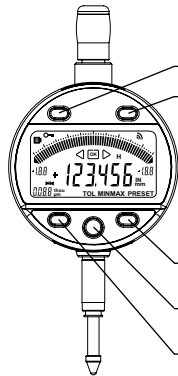
Per introdurre o modificare un valore numerico (Preset, livello nominale, scarto di tolleranza o fattore di moltiplicazione) si può procedere secondo due metodi:





7.1 Incremento / decremento del valore attuale :



-  Ridurre il valore attuale
-  Aumentare il valore attuale

Nota: - la velocità di scorrimento aumenta con la pressione prolungata del tasto
- salvare il valore con uno dei tre tasti inferiori



7.2 Introduzione cifra per cifra :

-  Incrementare la cifra selezionata
-  Selezionare la nuova cifra
-  Salvare il valore

8. Scala del display analogico

Una pressione breve su  o  permette di modificare i valori dell'intervallo del display analogico.

8.1 Funzione per centrare la scala analogica

Se i limiti di tolleranza sono asimmetrici rispetto al livello nominale, è possibile centrarli sulla scala analogica esercitando una pressione breve e simultanea su  e 

Esempio: $12.000 \begin{matrix} +0.025 \\ +0.020 \end{matrix}$

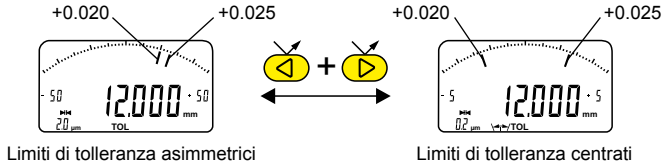

9. Configurazione *Bluetooth*[®] (a seconda del modello)

La procedura la connessione è stata pensata per essere semplice ed è indicata dai 3 seguenti stati:

- Simbolo ✖ spentomodalità scollegata
- Simbolo ✖ lampeggiantemodalità scoperta
- Simbolo ✖ accesomodalità collegata

È possibile selezionare le seguenti opzioni per controllare il modulo *Bluetooth*[®].

- On** Ativarre il modulo *Bluetooth*[®] (avviare la modalità di ricerca).
- OFF** Disabilita il modulo *Bluetooth*[®] (disattiva la connessione attiva).
- RESET** Cancellare le informazioni di accoppiamento.
- MAC** Visualizza l'indirizzo MAC (Media Access Control).

I Sono disponibili tre profili *Bluetooth*[®].

- SIMPLE** Profilo non accoppiato (per impostazione predefinita).
- PAIR** Profilo accoppiato e sicuro.
- HID** Modalità tastiera virtuale (compatibili con apparecchiature più recenti senza l'installazione del driver).

Nota:

- Le informazioni *Bluetooth*[®] vengono cancellate quando il profilo viene modificato.

Connessione :

- 1° Assicurarsi che l'applicazione e il l'apparecchio *Bluetooth*[®] compatibili siano attivi (PC, unità di misura).
- 2° Avviare lo strumento. Come impostazione predefinita il modulo *Bluetooth*[®] è attivo e lo strumento è collegabile (modalità scoperta).
- 3° Da quando lo strumento è rilevato il collegamento è automatico. Se la connessione non è stata stabilita mentre lo strumento è in modalità di rilevazione, riattivare il modulo *Bluetooth*[®] mediante il menu *bt / On*.
- 4° Lo strumento è pronto alla trasmissione (modalità collegata).

Accoppiamento :

L'accoppiamento dello strumento con la periferica avviene automaticamente all'avvio.

Per collegare uno strumento a una nuova periferica (nuovo accoppiamento) è necessario cancellare le informazioni di accoppiamento mediante il menu *bt / RESET*.



9.1 Specifiche *Bluetooth*[®]



Banda di frequenza	2.4GHz (2.402 - 2.480GHz)
Modulazione	GFSK (Gaussian Frequency Shift Keying)
Potenza massima in uscita	Classe 3: 1mW (0dBm)
Portata	Spazio aperto: fino a 15 m Ambiente industriale: 1-5m
Autonomia	Continuous : fino a 2 mesi (sempre connessi con i 4 valori / sec). Saver : fino a 5 mesi (Lo strumento invia valore solo quando la posizione è cambiata). Blind/Push : fino a 7 mesi (valore viene inviato dal (pulsante strumento) o richiesto dal computer).

Altre specifiche sul sito del produttore.

10. Tasto preferito

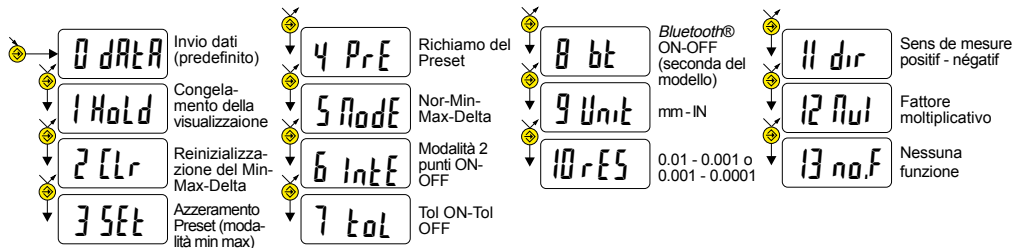
Il tasto «preferito» permette di accedere direttamente a una funzione predefinita e può essere configurato secondo le esigenze dell'utente. Per assegnare una funzione al tasto «preferito», applicare una pressione lunga su , quindi selezionare la funzione desiderata



Conferma della selezione: mediante pressione lunga su  o una breve pressione su  o 

Nota: la funzione può essere assegnata anche mediante RS 232, con il comando <FCT + N° di funzione>
esempio: Modifica di unità di misura = <FCT9>, direzione inversa di misura = <FCTB>

11. Regolazione e utilizzo della modalità di misura dinamica *IntE*

Talune applicazioni richiedono di regolare lo strumento sul valore MIN (o MAX) misurato. In questo caso si deve procedere come segue :

11.1 Regolazione dello strumento

- Introdurre un valore di Preset corrispondente alla dimensione effettiva del campione (consultare il capitolo 3)
- En el menú *IntE*, seleccione el modo -AMIN (selección automática del DIR- y modo MIN) ou +AMIN (selección automática del DIR+ y modo MIN) ou +AMAX (selección automática del DIR+ y modo MAX) según la medición a efectuar.
- Effettuare una misura del campione (comprendendo il valore massimo)
- Regolare lo strumento selezionando la modalità *Set* e premendo sul tasto  (consultare il capitolo 3)
- Lo strumento è regolato e pronto a effettuare misurazioni.

11.2 Misura

- Effettuare le misure comprendendo il valore massimo. Il display digitale memorizza e visualizza il valore MIN (o MAX) misurato.
- Prima di ogni nuova misura re inizializzare il valore misurato mediante una breve pressione su 

Esempli:

+ A_{min}
MEASURING

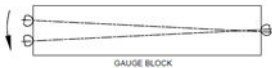

- A_{min}
MEASURING



+ A_{max}
MEASURING



SETTING RING



SETTING DISC



12. Spegnimento

Il comparatore va automaticamente in stand-by dopo 10 minuti di inattività, tranne se la modalità Auto OFF è disattivata (consultare il capitolo 4 funzioni di secondo livello)

È possibile forzare la modalità stand-by, con una pressione lunga (>2s) su  :

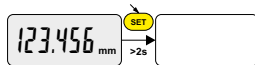



In modalità stand-by, il valore di origine è memorizzato dal sensore (modalità SIS), e lo strumento si riavvia automaticamente con un movimento del tasto di misura mediante il comando RS, *Bluetooth*[®] richiesta o premere un pulsante.

È possibile spegnere completamente lo strumento per un lungo periodo di non utilizzo, ma sarà necessario un azzeramento al momento del collegamento (perdita dell'origine):

- Applicare una pressione lunga (>4s) su  :



13. Reinizializzazione dello strumento

In qualsiasi momento è possibile ripristinare le impostazioni originali dello strumento con una pressione lunga (>4s) contemporanea su  e  fino a visualizzare il messaggio *rESET*.

14. Personalizzazione dello strumento

È possibile personalizzare l'accesso alle funzioni dello strumento mediante il software gratuito, il sito web del produttore (lo strumento deve essere connesso, con un cavo PROXIMITY o di alimentazione RS / USB).

Possibilità:

- Disattivare o attivare le funzioni desiderate
- Modificare l'accesso alle funzioni di secondo livello (messa in accesso diretto)

15. Connessione dello strumento

Lo strumento può essere connesso a una periferica mediante un cavo Proximity (RS o USB), o di POWER-RS e POWER-USB o *Bluetooth*[®]. Vedere pagina 2 per il collegamento dei cavi.

È possibile trasmettere i valori misurati e comandare lo strumento con dei retro-comandi predefiniti (elenco dei comandi principali, consultare il capitolo 16)

Nota:

In modalità Tolleranza, le spie dei limiti di tolleranza rimangono accese solo per pochi secondi mentre la misura si stabilizza. Resteranno accese in modo fisso se lo strumento è collegato e alimentato con il cavo POWER-RS e POWER-USB.

16. Elenco dei comandi principali

Selezione e configurazione

CHA+ / CHA-	Modifica direzione di misura
FCT0 ...9...A...F	Assegnazione funzione «preferito»
MM / IN	Modifica unità di misura
KEY0 / KEY1	Attiva / disattiva il blocco tastiera
MUL[+/-]xx.xxxx	Cambiando il fattore di moltiplicazione
PRE [+/-]xxx.xxx	Modifica valore di preset
STO1 / STO0	Attiva / disattiva HOLD
TOL1 / TOL0	Attiva / disattiva le tolleranze
ECO1 / ECO0	Attiva / disattiva la modalità economica
INTE1 / INTE0	2 punti modalità di misura
LCAL dd.mm.yy	Modifica data ultima calibratura
NCAL dd.mm.yy	Modifica data prossima calibratura
NUM x...x (fino a 20 car.)	Modificare il numero di strumento
TOL +/-xxx.xxx +/-yyy.yyy +/-zzz.zzz	Inserimento valore nominale e limiti di tol. attuali
MIN / MAX / DEL / NOR	Selezione modalità MIN, MAX, Delta, Normale
CLE	Reinizializzazione del MIN, MAX o Delta
UNI1 / UNI0	Attiva / disattiva il cambio di unità

OUT1 / OUT0	Attiva / disatt. trasmissione dati continua
PRE ON / PRE OFF	Attiva / disatt. la funzione Preset
PRE	Richiamo del Preset
SET	Azzeramento
RES1 / RES2 / RES3	Modifica risoluzione
AOFF	Activates/deactivates the automatic switch-off
CFGBAR	xxx
CFGBAR NOR MAX	Mantieni il Bargraph sul valore Max
SBY xx	xx numero di minuti prima dello Stand by

Bluetooth®

BT0/BT1	Attivare, disattivare il Bluetooth® modulo
BTRST	Reimpostare le informazioni di associazione

Interrogazione

CHA?	Senso di misura?
FCT?	Funzione «preferito» attiva?
UNI?	Unità di misura attiva?
KEY?	Blocco tastiera?
MUL?	Valore del fattore di moltiplicazione
PRE?	Valore di preset?
STO?	Stato funzione HOLD?
TOL?	Valore dei limiti di tol. attuali?
ECO?	Attuale modalità economica?
INTE ?	Misura 2 punti ?
LCAL?	Data ultima calibratura?
NCAL?	Data prossima calibratura?
NUM?	Numero di strumento?
?	Valore attuale (modalità Tol, valore seguito da <=>)
MOD?	Modalità attiva (MIN, MAX, Delta o Normale)?
SET?	Parametri principali dello strumento?
ID?	Codice d'identificazione dello strumento?

Funzioni di manutenzione

BAT?	Stato batteria (BAT1=Ok, BAT0=batteria scarica)
OFF	Spegnim. completo (riattivazione mediante pulsante o RS)
RST	Reinizializzazione dello strumento
SBY	Messa in Stand by dello strumento (SIS)
VER?	Revisione e data del firmware
CFGBAR?	Configurazione di Bargraph
MAC?	Bluetooth® MAC address?

17. Specifiche



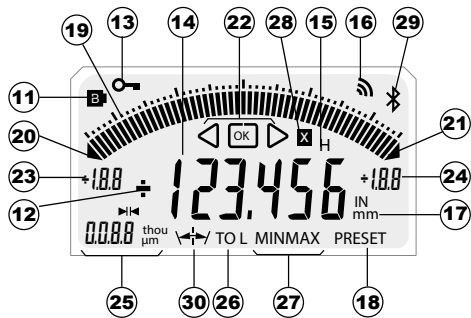
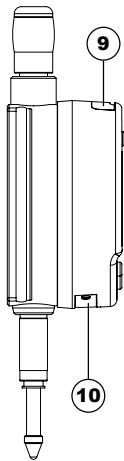
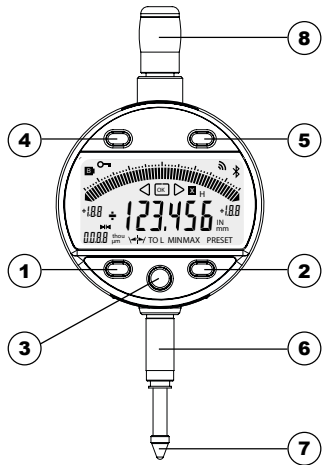

Campo di misura:	12.5mm	25mm	
Errore max (risoluzione 10µm):	10µm	10µm	(±1 digit)
Errore max (risoluzione 1µm):	3µm	4µm	
Errore max (risoluzione 0.1µm):	1.8µm	2.2µm	
Ripetibilità:		2µm	
Peso:	119g	123g	
Forza di misura (standard):	0.65-0.9N	0.65-1.15N	
Velocità max. di spostamento:		1.7m/s	
N. di misure al secondo:	misura: 10 mis/s		modalità MIN/MAX: 20 mis/s
Unità di misura:	metrica/inglese (Inch)		
Preset massimo (risoluzione 10µm):	±9999.99 mm / ±399.9995 IN		
Preset massimo (risoluzione 1µm):	±999.999 mm / ±39.99995 IN		
Preset massimo (risoluzione 0.1µm):	±99.9999 mm / ±3.999995 IN		
Valore intervallo scala analogica:	min 0.2 µm - max 1 mm / min 0.01 thou - 0.05 IN		
Capacità scala analogica:	min ±5 µm - max ±25 mm / min ± 0.25 thou - max ± 1.25 IN		
Sistema di misura:	Sistema Sylvac induttivo (brevettato)		
Alimentation:	1 batteria al litio 3 V, tipo CR2032, capacità 220 mAh		
Autonomia media:	8.000 ore (Bluetooth® cap 9.1)		
Uscita dati:	compatibile RS232/USB		
Temperatura operativa (stoccaggio):	da +5 a +40 °C (da -10 a +60 °C)		
Compatibilità elettromagnetica:	secondo EN 61326-1		
Specifica IP (secondo IEC60529):	IP 54		
Fissaggio e ingombro:	fissaggio Ø8h6 (3/8"), tasto di misura intercambiabile M2.5 (4-48-UNF) (secondo DIN 878)		



Descripción

1. Botón Modo
2. Botón Configuración
3. Botón « Favoritos »
4. Botón ◀
5. Botón ▶
6. Cañón de fijación Ø8 o 3/8"
7. Palpador de bola Ø2/M2.5 o 4-48-UNF
8. Corona de elevación
9. Alojamiento para cable Proximity
10. Alojamiento para batería o cable Power
11. Batería baja
12. Indicadores +/-
13. Bloqueo del teclado (cap. 4)
14. Visualización de 6 dígitos
15. Congelación del valor de medición (cap. 10)
16. Envío de datos (cap. 10)
17. Unidad de medida mm/pulgadas (cap. 3)
18. Modo Preset (cap. 3)
19. Escala analógica (cap. 8)
20. Superación del límite inferior
21. Superación del límite superior
22. Indicadores de tolerancia
23. Límite inferior de la escala analógica (cap. 8)
24. Límite superior de la escala analógica (cap. 8)
25. Unidad y valor del escalón analógico (cap. 8)
26. Modo Tolerancias (cap. 4)
27. Modo MIN/MAX/DELTA (cap. 4)
28. Multiplicador (cap. 4)
29. *Bluetooth*[®] (depende de la versión)
30. Tolerancias simétricas (cap. 8.1)

1. Funcionalidades del equipo

-  El equipo dispone de 2 modos de trabajo: funciones de primer nivel (con acceso directo) y funciones de segundo nivel. Además de las funciones de configuración hay acceso en modo MIN, MAX y DELTA (TIR), o en visualización de tolerancias. (ver cap. 3 y 4)
-  La tecla «favorito» atribuye un acceso directo a la función utilizada de manera principal (ver cap. 9)
-  Atribuye un valor predefinido, reinicializa el modo MIN/MAX, borra una selección y gestiona el apagado del equipo. Por defecto, el modo SIS permite apagar de manera automática sin pérdida de original (ver cap. 11).
-  Los botones “Izquierda” y “Derecha” permiten modificar el alcance de la escala analógica, los valores de la dimensión nominal y de los límites de tolerancia. (ver cap. 6.2).
- 

- Personalización de las funciones

Es posible activar o desactivar ciertas funciones del equipo por RS232 (ver cap. 13)

- Parámetros de transmisión de datos

4800Bds, 7 bits, paridad par, 2 bits de parada

2. Arranque

Pulse un botón. En el primer empleo, el equipo pedirá seleccionar la unidad de medida deseada (*mm* o *inch*). Seleccione... y mida

3. Funciones de primer nivel

Cada pulsación breve sobre **MODE** permite acceder directamente a las funciones de primer nivel:

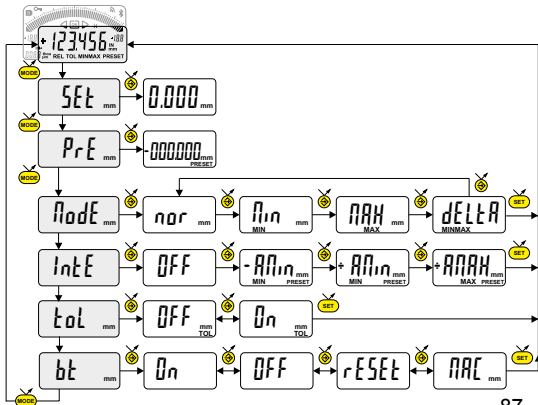

- Modo normal: Puesta a cero
 - Modo mín (máx): Prestablecido con respecto al valor mín. (máx.) medido
- Introducción de un valor predefinido (ver cap. 7)

Medición del MÍNIMO, MÁXIMO
DELTA (TIR) (ver cap. 5)

Modo 2 puntos (Preset dinámico)(consulte el capítulo 11)

Visualización de tolerancias (introducción de los límites de tolerancia, ver cap. 6)

Bluetooth® (dependiendo de la versión). Activar / desactivar, reiniciar el versión Bluetooth® o mostrar la dirección MAC.

4. Funciones de segundo nivel

Al pulsar prolongadamente (>2 seg) sobre **MODE** accederá a las funciones de segundo nivel. Pulsando brevemente en **MODE** accederá a la función deseada:

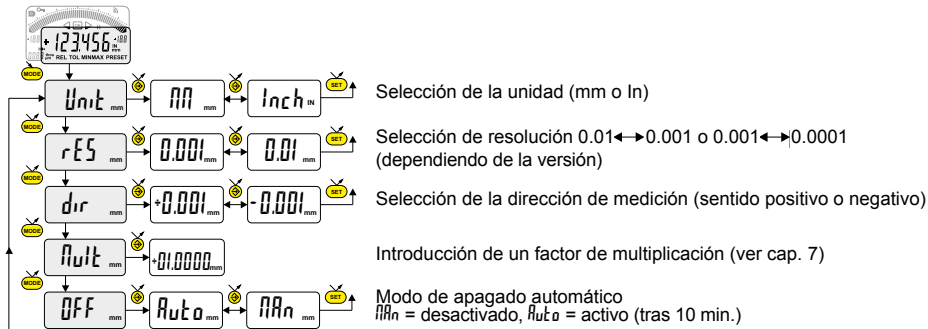

..... continuación

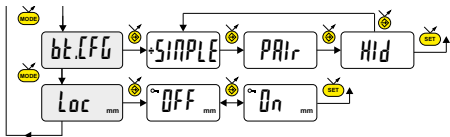



Selección del perfil *Bluetooth*[®] (según la versión).
(Ver cap. 6 para más detalles) El símbolo + indica el perfil activo.

Bloqueo del teclado. Solo funciones de datos y CLR del botón favorito queda activa ((para desactivar el bloqueo del teclado,pulse SET durante 5 segundos.)

5. Funcionamiento en modo MÍNIMO, MÁXIMO y DELTA (TIR) :

En ese modo de funcionamiento, la pantalla digital memoriza el valor MIN, MAX o DELTA. Por el contrario, la escala analógica indica siempre el valor actual medido.

- Una pulsación breve de  reinicializa el valor MIN/MAX memorizado (CLEAR)
- Una pulsación prolongada (>2s) de  atribuye el valor Preset a la posición de medición actual.

6. Introducción (o modificación) de los límites de tolerancia

Los límites de tolerancia se definen introduciendo el desfase inferior y superior con respecto a la cota nominal. Pueden emplearse dos métodos:

6.1 Utilización del modo TOL

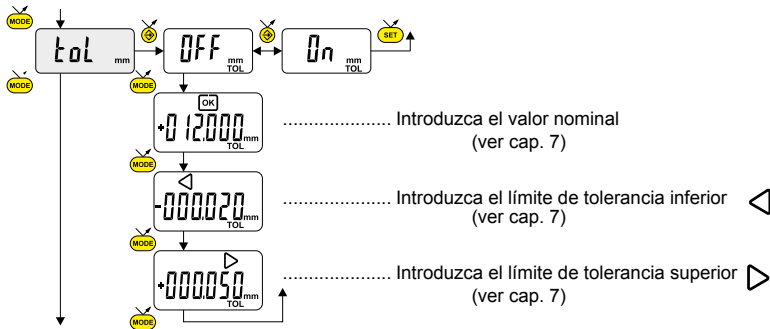

6.2 Utilización de los botones ◀ y ▶ :

También se puede introducir o modificar el valor nominal o los límites de tolerancia mediante una pulsación prolongada

(>2seg) de ◀ y/o ▶ :

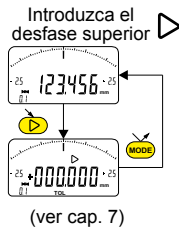
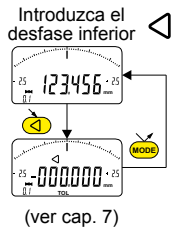
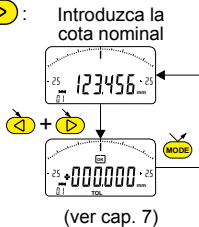

Notas :

- También es posible mostrar los límites de tolerancia cuando el equipo trabaja en modo MIN, MAX o DELTA (TIR)
- Si el usuario no ha definido ningún límites de tolerancia, el instrumento mostrará los indicadores de límites de tolerancias pero sin activar los indicadores luminosos (rojo - verde - amarillo)
- Si se están midiendo cotas interiores, se pueden cruzar los indicadores (rojo y amarillo) invirtiendo el orden de introducción de los desfases de tolerancia (desfase superior < desfase inferior).

7 Introducción de un valor numérico

Para introducir o modificar un valor numérico (Preset, cota nominal, desfases de tolerancia o factor de multiplicación), pueden emplearse dos métodos:

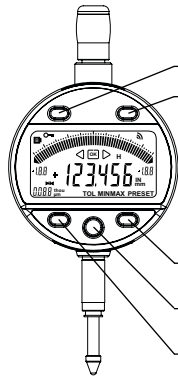

7.1 Incremento/decremento del valor actual:



- ◀ Decrece el valor actual
- ▶ Incrementa el valor actual

Nota: - la velocidad de barrido de los valores aumenta si el botón se mantiene pulsado de forma prolongada
- guardar el valor con uno de los tres botones inferiores

7.2 Introducción dígito a dígito:

- SET Incremento del dígito seleccionado
- Selección del siguiente dígito
- MODE Guarda el valor

8. Escala de la visualización analógica

Una pulsación breve de  o  permite modificar el valor del escalón de la visualización analógica.

8.1 Función de centrado de la escala analógica

Si los límites de tolerancia son asimétricos con respecto a la cota nominal, pueden recentrarse en la escala analógica mediante una pulsación breve y simultánea de  y 

Ejemplo: $12.000 \begin{matrix} +0.025 \\ +0.020 \end{matrix}$

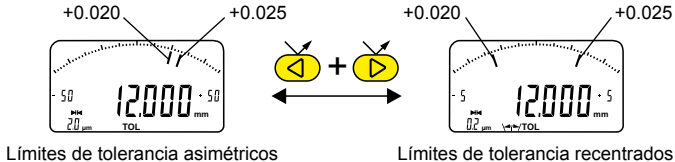

9. Configuración *Bluetooth*[®] (depediendo del modelo)

El procedimiento de conexión está pensado para que sea sencillo y se caracteriza por los 3 estados siguientes :

- Símbolo ✖ apagadomodo desconectado
- Símbolo ✖ parpadeantemodo detección
- Símbolo ✖ encendidomodo conectado

Se pueden seleccionar las siguientes opciones para controlar el módulo *Bluetooth*[®].

- On** Habilitar el módulo *Bluetooth*[®] (iniciar el modo de advertencia).
- OFF** Desactiva módulo *Bluetooth*[®] (terminar la coexión activa).
- rESEt** Eliminar su información de emparejamiento.
- MAC** Muestra la dirección MAC (Media Access Control).

Tres perfiles de *Bluetooth*[®] están disponibles.

- SIMPLE** Perfil no apareado (por defecto).
- PAIR** Perfil apareado y seguro.
- Hid** Modo teclado virtual (compatible con equipos recientes sin instalación del controlador).

Observaciones :

- La información de *Bluetooth*[®] se borra cuando se cambia el perfil.

Conexión :

1° Compruebe que la aplicación y el *Bluetooth*[®] compatibles están activos (PC, unidad de medida).

2° Encienda el dispositivo. El módulo *Bluetooth*[®] está activo por defecto y el dispositivo es conectable (modo detección).

3° En cuanto se detecta el dispositivo, la conexión es automática. Si la conexión no se establece, durante que el instrumento se encuentre en modo búsqueda, reactivar el módulo *Bluetooth*[®] vía el menú *bt / On* .

4° El dispositivo está listo para transmitir (modo conectado)

Solo con perfil emparejamiento :

El perfil del dispositivo con el maestro es automático en la primera conexión.

Para conectar un dispositivo a otro maestro (nuevo emparejamiento), hay que eliminar su información de emparejamiento desde el menú *bt / rESt* .

9.1 Especificación *Bluetooth*[®]

Banda de frecuencia	2.4GHz (2.402 - 2.480GHz)
Modulación	GFSK (Gaussian Frequency Shift Keying)
Potencia máxima de salida	Clase 3: 1mW (0dBm)
Alcance	Espacio abierto: hasta 15m Entorno industrial: 1-5m
Autonomía	Continuous : hasta 2 meses (siempre conectados con 4 valores / seg). Saver : hasta 5 meses (El instrumento envía valor sólo cuando la posición ha cambiado). Blind/Push : hasta 7 meses (Valor se envía desde el (botón de instrumento) se puede solicitar a la computadora).

Otras especificaciones sobre el sitio web del fabricante.

10. Tecla favorito

Con la tecla «favorito» se accede directamente a una función predefinida y puede configurarse según las necesidades del usuario. Para atribuir una función a la tecla «favorito» pulse prolongadamente sobre  y seleccione la función deseada:

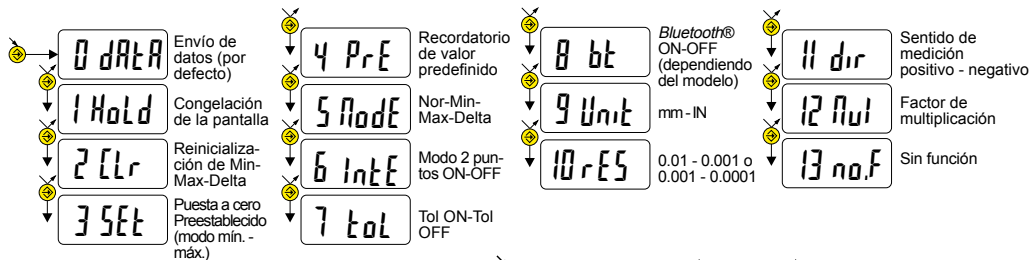

Validación de la selección: Pulsando prolongadamente en  o brevemente en **MODE** o en **SET**

Observaciones: puede atribuirse también la función por RS232 con las teclas <FCT + N° de función>
ejemplo: Cambio de unidad de medida = <FCT9>, dirección de medición inversa = <FCTB>

11. Ajuste y uso del modo de medición dinámica *IntE*

Algunas aplicaciones precisan que el instrumento se ajuste con respecto al valor MIN (o MAX) medido. En ese caso, debe seguirse el siguiente procedimiento :

11.1 Ajustado del instrumento

- Introduzca un valor de Preset correspondiente a la dimensión efectiva del patrón (ver cap. 3)
- En el menú *IntE*, seleccione el modo +AMIN (configure DIR+ y el modo MIN) o bien el modo +AMAX (configure DIR+ y el modo MAX) según la medición a efectuar.
- Efectúe una medición del patrón (pasando por el punto cuspidal)
- Ajustar el instrumento seleccionando el modo *IntE* y pulsando el botón  (ver cap. 3)
- El instrumento está ajusto, listo para medir.

11.2 Medición

- Efectúe las mediciones pasando por el punto cuspidal. La pantalla digital memoriza y muestra el valor MIN (o MAX) medido.
- Antes de cada nueva medición, reinicialice el valor medido pulsando brevemente 

Ejemplos:

+ A_{min}
MEASURING

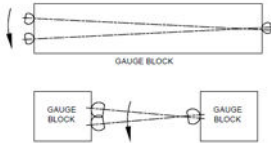

- A_{min}
MEASURING



+ A_{max}
MEASURING

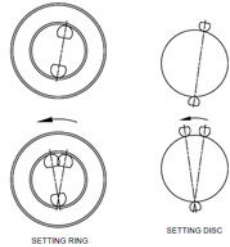

12. Apagado

El comparador hibernará automáticamente tras 10 minutos de inactividad salvo que el modo Auto OFF esté desactivado (ver Cap. 4, Funciones de segundo nivel)

Es posible forzar el modo de hibernación pulsando prolongadamente (> 2 seg)

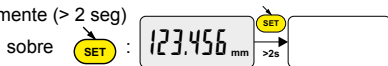



En modo hibernación el sensor conserva el valor original (modo SIS) y el equipo se reanuda automáticamente por un movimiento de la tecla de medición por control RS, *Bluetooth*[®] solicitud, o pulse un botón.

Es posible apagar el equipo en períodos largos en los que no se utilice pero esto implicará una puesta a cero al arranque de nuevo (pérdida del origen):



13. Reinicialización del equipo

Los ajustes iniciales del equipo pueden restaurarse en cualquier momento pulsando prolongadamente (> 4 seg) y al mismo tiempo que  y  hasta que se muestre el mensaje *rESEt*.

14. Personalización del equipo

Es posible personalizar el acceso a las funciones de su equipo con el programa gratuito para más información, véase el sitio web del fabricante (requiere conexión de su equipo con cable Proximity o Power RS / USB).

Esta aplicación permite:

- Desactivar o activar las funciones deseadas
- Modificar el acceso a las funciones de segundo nivel (acceso directo)

15. Conexión del equipo

El equipo puede conectarse a un periférico con un cable Proximity (RS o USB), o Power-RS (Power-USB) o *Bluetooth*[®]. Consultar la página 2 para la conexión de los cables.

Los valores medidos pueden transmitirse y puede controlarse el instrumento con comandos predefinidos (lista de comandos principales en el cap. 16)

Observaciones :

En modo Tolerancia, los indicadores luminosos de los límites de tolerancia se iluminan sólo unos segundos cuando la medición se ha estabilizado. Sin embargo se mantendrán iluminados si el instrumento está conectado y recibe alimentación con el cable Power RS (USB).

16. Lista de comandos principales

Selección y configuración Pregunta

CHA+ / CHA-	Cambio de dirección de medición
FCT0 ...9...A...F	Atribución de función «favorito»
MM / IN	Cambio de unidad de medida
KEY0 / KEY1	Activa / desactiva el bloqueo de teclado
MUL[+/-]xx.xxxx	Cambiando el factor de multiplicación
PRE [+/-]xxx.xxx	Modificación del valor predefinido
STO1 / STO0	Activa / desactiva el HOLD
TOL1 / TOL0	Activa / desactiva las tolerancias
ECO1 / ECO0	Activa / desactiva el modo económico
INTE 1 / INTE 0	2 puntos mode de Medición
LCAL dd.mm.yy	Modifica fecha de última calibración
NCAL dd.mm.yy	Modifica fecha de próxima calibración
NUM x...x (hasta 20 char)	Modificar el número de instrumento
TOL +/-xxx.xxx +/-yyy.yyy +/-zzz.zzz	Introducción del valor nominal y de los límites de tol. actuales
MIN / MAX / DEL / NOR	Selección del modo MIN, MAX, Delta, Normal
CLE	Reinicio del MIN, MAX o Delta
UNI1 / UNI0	Activa / desactiva el cambio de unidad

OUT1 / OUT0	Activa / desact. transmisión continua de datos
PRE ON / PRE OFF	Activa / desactiva la función Preset
PRE	Recordatorio del Preset
SET	Puesta a cero
RES1 / RES2 / RES3	Cambio de resolución
AOFF	Activates/deactivates the automatic switch-off
CFGBAR	xxx
CFGBAR NOR MAX	Mantenga la barra gráfica en el valor máximo
SBY xx	xx cantidad de minutos antes de la hibernación

S
Bluetooth®
BT0/BT1
BTRST

Habilitar/desactivar el *Bluetooth®* módulo
restablecer la información de emparejamiento

CHA?	¿Sentido de medición?
FCT?	¿Función «favorito» activada?
UNI?	¿Unidad de medida activada?
KEY?	¿Bloqueo de teclado?
MUL?	Valor del factor de multiplicación
PRE?	¿Valor predefinido?
STO?	¿Estado de la función HOLD?
TOL?	¿Valor de límites de tol. actuales?
ECO?	¿Modo económico actual?
INT ?	¿ Mode 2 puntos?
LCAL?	¿Fecha de última calibración?
NCAL?	¿Fecha de próxima calibración?
NUM?	¿Número de instrumento?
?	¿Valor actual (modo Tol, valor seguido de <=>)?
MOD?	¿Modo activo? (MIN, MAX, Delta o Normal)
SET?	¿Configuración principal del instrumento?
ID?	¿Código de identificación del instrumento?

Funciones de mantenimiento

BAT?	Estado batería (BAT1=Ok, BAT0=batería baja)
OFF	Apagado completo (arranque con botón o RS)
RST	Reinicialización del equipo
SBY	Hibernación del equipo (SIS)
VER?	Revisión y fecha del firmware.
CFGBAR?	Configuración de gráfico de barras
MAC?	<i>Bluetooth®</i> MAC address?

17. Specifications

Alcance de la medición:	12.5mm	25mm	
Error máx. (escala 10µm):	10µm	10µm	(±1 digit)
Error máx. (escala 1µm):	3µm	4µm	
Error máx. (escala 0.1µm):	1.8µm	2.2µm	
Repetibilidad:		2µm	
Peso:	119g	123g	
Fuerza de medición (estándar):	0.65-0.9N	0.65-1.15N	
Velocidad máxima de desplazamiento:	1.7m/seg.		
N1 de mediciones por segundo:	medición: 10 med/s modo MIN/MAX: 20 med/seg.		
Unidad de medida:	métrico / imperial (pulgadas)		
Preset máximo (escala 10µm):	±9999.99 mm / ±399.9995 IN		
Preset máximo (escala 1µm):	±999.999 mm / ±39.99995 IN		
Preset máximo (escala 0.1µm):	±99.9999 mm / ±3.999995 IN		
Valor del escalón de la escala analógica:	min 0.2 µm - max 1 mm / min 0.01 thou - 0.05 IN		
Capacidad de la escala analógica:	min ±5 µm - max ±25 mm / min ± 0.25 thou - max ± 1.25 IN		
Sistema de medida:	Sylvac inductive system (patentado)		
Alimentación:	1 batería litio 3V, tipo CR2032, capacidad 220mAh		
Autonomía media:	8'000 horas (Bluetooth® cap 9.1)		
Salida de datos:	compatible RS232/USB		
Temperatura de trabajo (almacenamiento):	+5 hasta +40°C (-10 hasta +60°C)		
Compatibilidad electromagnética:	según EN 61326-1		
Especificación IP (según IEC60529):	IP 54		
Fijación y volumen:	fijación Ø8h6 (3/8"), tecla de medición intercambiable M2.5 (4-48-UNF) (según DIN 878)		

Notes / Notes / Aufzeichnungen / Note / Notas

CERTIFICATE OF CONFORMITY

We certify that this instrument has been manufactured in accordance with our Quality Standard and tested with reference to masters of certified traceability by the National Office of Metrology.

CERTIFICAT DE CONFORMITE

Nous certifions que cet instrument a été fabriqué et contrôlé selon nos normes de qualité et en référence avec des étalons dont la traçabilité est reconnue par l'office national de métrologie.

QUALITÄTSZEUGNIS

Wir bestätigen, dass dieses Gerät gemäss unseren internen Qualitätsnormen hergestellt wurde und mittels Normalen mit anerkannter Rückverfolgbarkeit, kalibriert durch das Nationalamt für Metrologie, geprüft worden ist.

CERTIFICATO DI CONFORMITÀ

Con il presente si certifica che questo strumento è stato prodotto secondo il nostro standard sulla qualità e controllato rispetto a campioni di riferibilità riconosciuta dall'ufficio nazionale di metrologia

CERTIFICADO DE CONFORMIDAD

Certificamos que este instrumento ha sido fabricado conforme a nuestras normas de calidad y ha sido controlado en relación con patrones de trazabilidad reconocida por la oficina nacional de metrología.

Calibration certificate

Because we make our instruments in batches, you may find that the date on your calibration certificate is not current. Please be assured that your instruments are certified at point of production and then held in stock in our warehouse in accordance with our Quality Management System ISO 9001. Re-calibration cycle should start from date of receipt.

Certificat d'étalonnage

En raison de la fabrication de nos instruments par lots de production, il est possible que la date de votre certificat d'étalonnage ne soit pas actuelle. Nous garantissons que nos instruments sont certifiés au moment de leur fabrication puis stockés conformément à notre système de gestion de la qualité ISO 9001. Le cycle de réétalonnage peut commencer à partir de la date de réception.

Zertifikat

Da wir unsere Instrumente in Serien herstellen, kann es sein, dass das Datum auf dem Zertifikat nicht aktuell ist. Die Instrumente sind jedoch ab der Herstellung zertifiziert und werden dann gemäß unserem Qualitätsmanagementsystem ISO 9001 in unserem Lager aufbewahrt. Der Nachkalibrierungszyklus kann ab dem Empfangsdatum beginnen.

Certificado de calibración

Puesto que fabricamos nuestros instrumentos por lotes, puede que la fecha de su informe de prueba / certificado de calibración no esté al día. Asegúrese de que los instrumentos estén certificados en nuestro lugar de producción y estén almacenados en nuestro almacén conforme a nuestro sistema de control de calidad ISO 9001. El ciclo de recalibración puede empezar a partir de la fecha de recepción.

Certificato di taratura

Considerata la nostra produzione in serie di strumenti, è possibile verificare che la data di produzione sul rapporto di prova / certificato di taratura non è attuale. Accertarsi che gli strumenti siano correttamente certificati dalla nostra produzione e che sono conservati in stock presso il nostro magazzino secondo il sistema di gestione della qualità ISO 9001. Il ciclo di nuova taratura può essere avviato dalla data di ricezione.

The *Bluetooth*® word mark and logos are registered trademarks owned by the *Bluetooth*® SIG, Inc. and any use of such marks by Sylvac is under license. Other trademarks and trade names are those of their respective owners.

U.S./Canada Certification

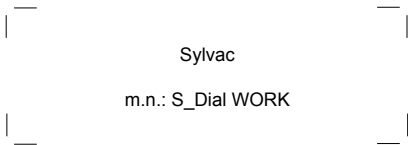

This device contains
FCC ID: 2AAQS-ISP091201
IC: 11306A-ISP091201

NOTICE:

Changes or modifications made to this equipment not expressly approved by Sylvac may void the FCC authorization to operate this equipment.

NOTICE:

This device complies with Part 15 of the FCC Rules and with RSS-210 of Industry Canada. Operation is subject to the following two conditions.

- (1) this device may not cause harmful interference, and
- (2) this device must accept any interference received, including interference that may cause undesired operation.

NOTE:

This equipment has been tested and found to comply with the limits for a Class A digital device, pursuant to Part 15 of the FCC Rules. These limits are designed to provide reasonable protection against harmful interference when the equipment is operated in a commercial environment. This equipment generates, uses, and can radiate radio frequency energy and, if not installed and used in accordance with the instruction manual, may cause harmful interference to radio communications. Operation of this equipment in a residential area is likely to cause harmful interference in which case the user will be required to correct the interference at his own expense.

Radiofrequency radiation exposure Information:

This equipment complies with FCC radiation exposure limits set forth for an uncontrolled environment. This equipment should be installed and operated with minimum distance of 20 cm between the radiator and your body.

This transmitter must not be co-located or operating in conjunction with any other antenna or transmitter.

Brazil Certification

Description:

This module is based on Nordic Semiconductor nRF8001 μ Blue *Bluetooth*[®] Low Energy Platform. The nRF8001 is a single chip transceiver with an embedded baseband protocol engine, suitable for ultra-low power wireless applications conforming to the *Bluetooth*[®] Low Energy Specification contained within v4.0 of the overall *Bluetooth*[®] specification. The nRF8001, used in the current revision of ISP091201, is a production product using a RoM for the baseband protocol engine.

Este equipamento opera em caráter secundário, isto é, não tem direito à proteção contra interferência prejudicial, mesmo de estações do mesmo tipo e não pode causar interferência a sistemas operando em caráter primário.



Mexico certification

Contiene modulo inalámbrico
Marca: Sylvac
Modelo: ISP091201D
IFT: RCPSYIS14-0655

La operación de este equipo está sujeta a las siguientes dos condiciones: (1) es posible que este equipo o dispositivo no cause interferencia perjudicial y (2) este equipo o dispositivo debe aceptar cualquier interferencia, incluyendo la que pueda causar su operación no deseada.

Korea South certification

MSIP-CRM-iNs-ISP091201

Class A Equipment (Industrial Use)

이 기기는 업무용(A급) 전자파적합기기로서 판매자 또는 사용자는 이 점을 주의하시기 바라며, 가정 외의 지역에서 사용하는 것을 목적으로 합니다.

Japan certification



R

001-A06167



Changes without prior notice

Sous réserve de toute modification

Änderungen vorbehalten

Soggetto a modifica senza preavviso

Reservados los derechos de modificación sin previo aviso

Edition : 2018.06 - for web using only